

ALUMINUM DISC RACK ASSEMBLY

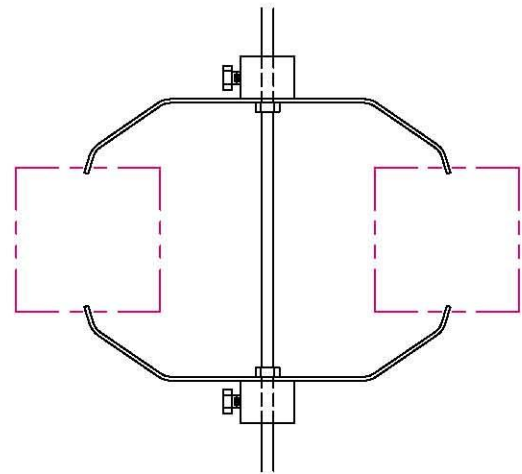

Disc With Block Collar

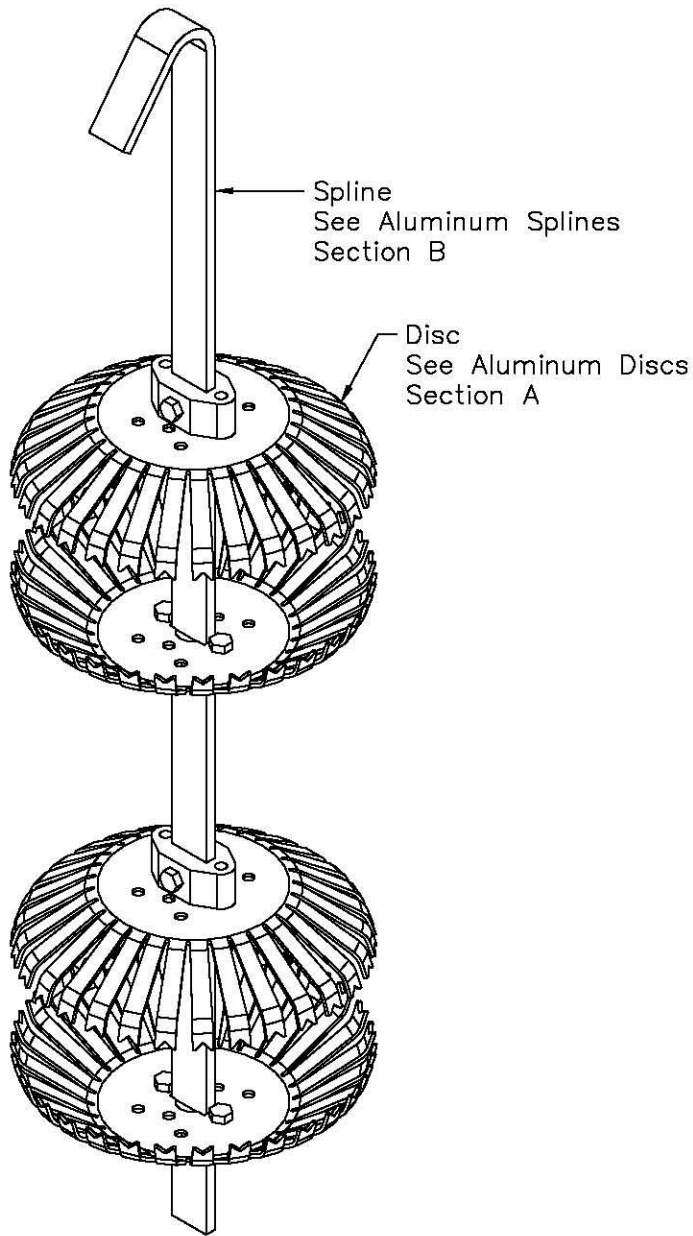
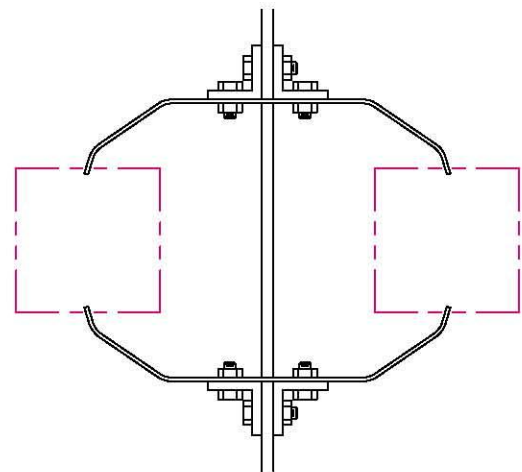

Disc With Angle Bracket

ALUMINUM SPLINES

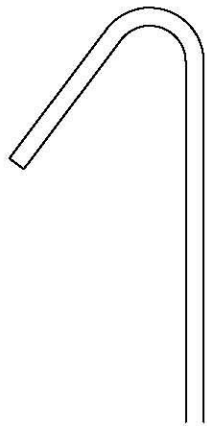

Hook Styles

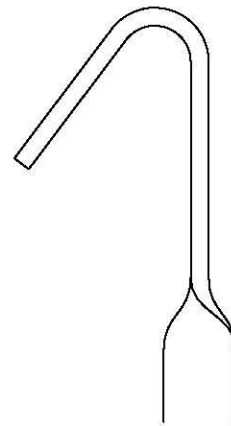

1/4" X 3/4"

HOOK STYLES

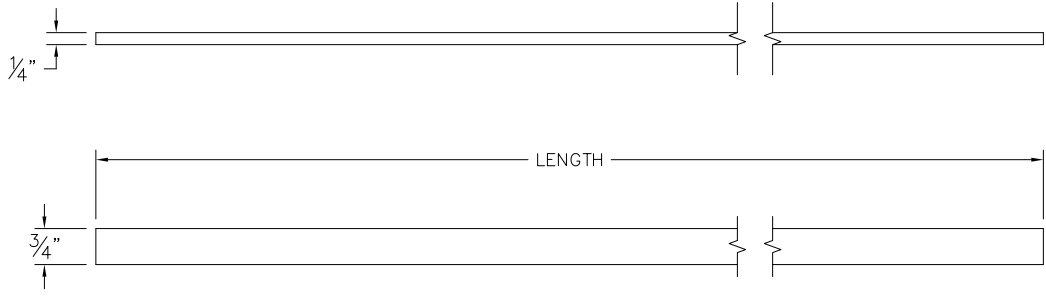

NO HOOK

LENGTH	NO HOOK	PLAIN HOOK	HOOK WITH TWIST
30"	AS30-26-NHK	AS30-26-PHK	AS30-26-THK
36"	AS36-26-NHK	AS36-26-PHK	AS36-26-THK
42"	AS42-26-NHK	AS42-26-PHK	AS42-26-THK
48"	AS48-26-NHK	AS48-26-PHK	AS48-26-THK
54"	AS54-26-NHK	AS54-26-PHK	AS54-26-THK
60"	AS60-26-NHK	AS60-26-PHK	AS60-26-THK

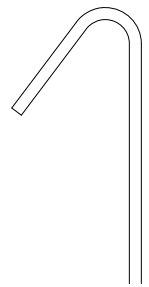

PLAIN HOOK

- HOLE: 17/64" DIA.

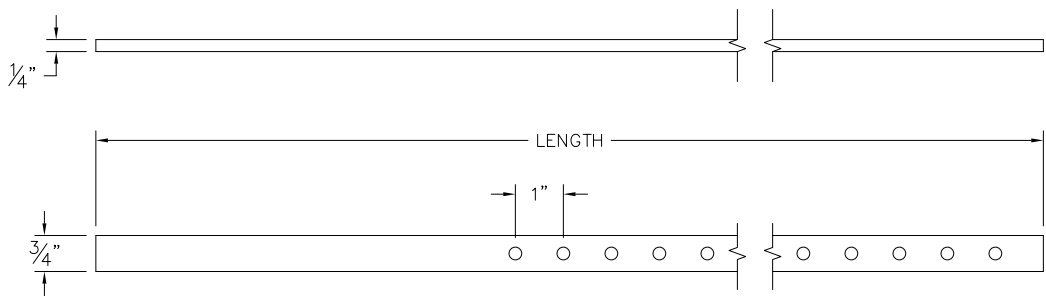

LENGTH	NO HOOK	PLAIN HOOK	HOOK WITH TWIST
30"	AS30-26-NHKK	AS30-26-PHKK	AS30-26-THKH
36"	AS36-26-NHKK	AS36-26-PHKK	AS36-26-THKH
42"	AS42-26-NHKK	AS42-26-PHKK	AS42-26-THKH
48"	AS48-26-NHKK	AS48-26-PHKK	AS48-26-THKH
54"	AS54-26-NHKK	AS54-26-PHKK	AS54-26-THKH
60"	AS60-26-NHKK	AS60-26-PHKK	AS60-26-THKH

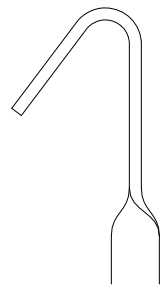

HOOK WITH TWIST

- SLOT: 17/64" X 3-1/2"

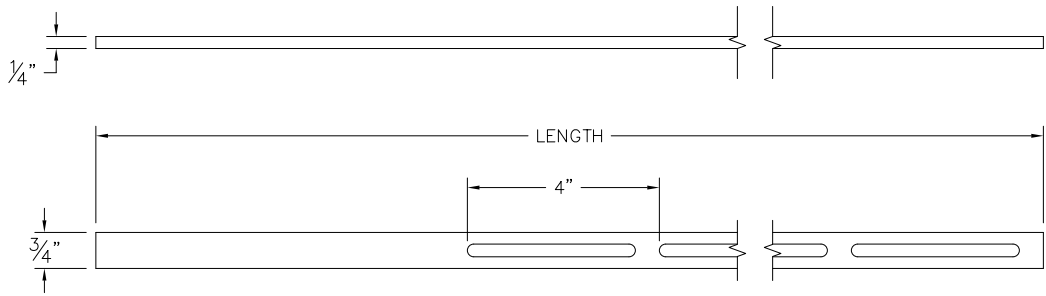

LENGTH	NO HOOK	PLAIN HOOK	HOOK WITH TWIST
30"	AS30-26-NHKS	AS30-26-PHKS	AS30-26-THKS
36"	AS36-26-NHKS	AS36-26-PHKS	AS36-26-THKS
42"	AS42-26-NHKS	AS42-26-PHKS	AS42-26-THKS
48"	AS48-26-NHKS	AS48-26-PHKS	AS48-26-THKS
54"	AS54-26-NHKS	AS54-26-PHKS	AS54-26-THKS
60"	AS60-26-NHKS	AS60-26-PHKS	AS60-26-THKS

1/4" X 1"

HOOK STYLES

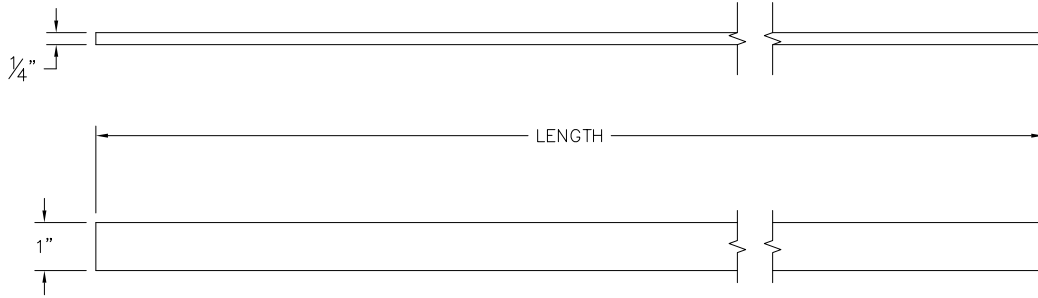

NO HOOK

LENGTH	NO HOOK	PLAIN HOOK	HOOK WITH TWIST
30"	AS30-28-NHK	AS30-28-PHK	AS30-28-THK
36"	AS36-28-NHK	AS36-28-PHK	AS36-28-THK
42"	AS42-28-NHK	AS42-28-PHK	AS42-28-THK
48"	AS48-28-NHK	AS48-28-PHK	AS48-28-THK
54"	AS54-28-NHK	AS54-28-PHK	AS54-28-THK
60"	AS60-28-NHK	AS60-28-PHK	AS60-28-THK

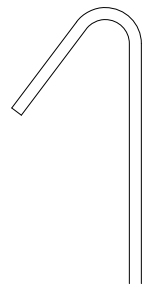

PLAIN HOOK

- HOLE: 17/64" DIA.

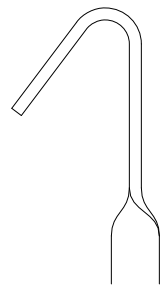
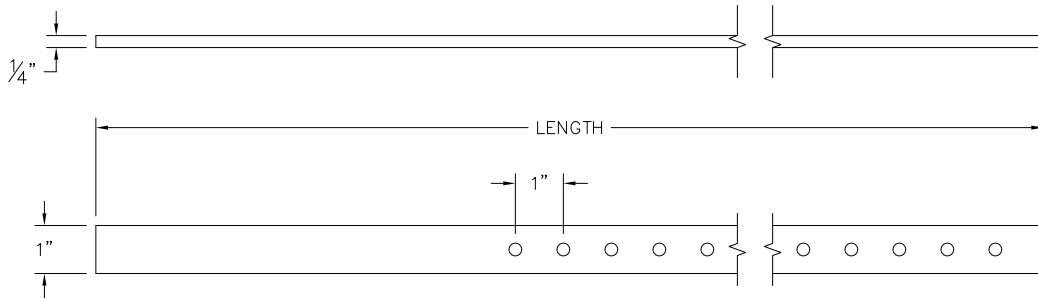

HOOK WITH TWIST

LENGTH	NO HOOK	PLAIN HOOK	HOOK WITH TWIST
30"	AS30-28-NHKK	AS30-28-PHKK	AS30-28-THKH
36"	AS36-28-NHKK	AS36-28-PHKK	AS36-28-THKH
42"	AS42-28-NHKK	AS42-28-PHKK	AS42-28-THKH
48"	AS48-28-NHKK	AS48-28-PHKK	AS48-28-THKH
54"	AS54-28-NHKK	AS54-28-PHKK	AS54-28-THKH
60"	AS60-28-NHKK	AS60-28-PHKK	AS60-28-THKH

- SLOT: 17/64" X 3-1/2"

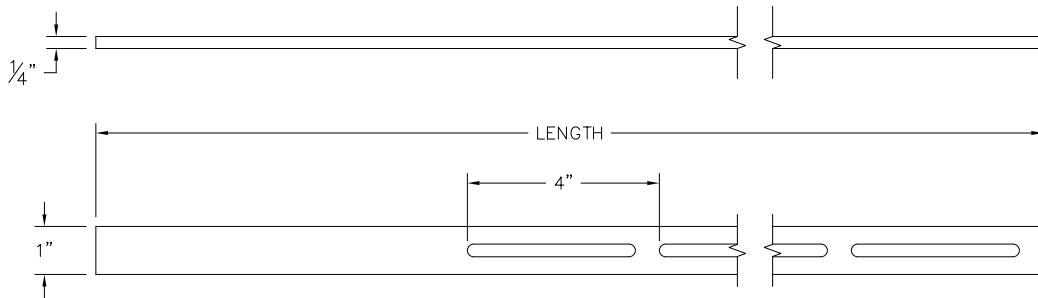

LENGTH	NO HOOK	PLAIN HOOK	HOOK WITH TWIST
30"	AS30-28-NHKS	AS30-28-PHKS	AS30-28-THKS
36"	AS36-28-NHKS	AS36-28-PHKS	AS36-28-THKS
42"	AS42-28-NHKS	AS42-28-PHKS	AS42-28-THKS
48"	AS48-28-NHKS	AS48-28-PHKS	AS48-28-THKS
54"	AS54-28-NHKS	AS54-28-PHKS	AS54-28-THKS
60"	AS60-28-NHKS	AS60-28-PHKS	AS60-28-THKS

1/4" X 1-1/2"

HOOK STYLES

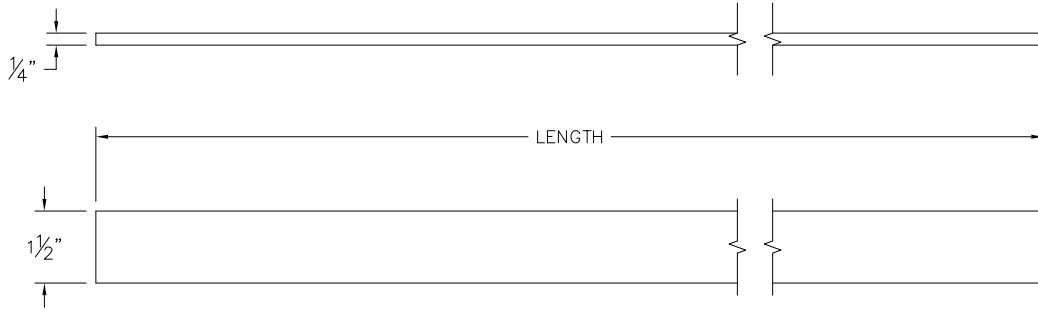

NO HOOK

LENGTH	NO HOOK	PLAIN HOOK	HOOK WITH TWIST
30"	AS30-212-NHK	AS30-212-PHK	AS30-212-THK
36"	AS36-212-NHK	AS36-212-PHK	AS36-212-THK
42"	AS42-212-NHK	AS42-212-PHK	AS42-212-THK
48"	AS48-212-NHK	AS48-212-PHK	AS48-212-THK
54"	AS54-212-NHK	AS54-212-PHK	AS54-212-THK
60"	AS60-212-NHK	AS60-212-PHK	AS60-212-THK

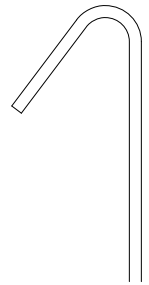

PLAIN HOOK

- HOLE: 17/64" DIA.

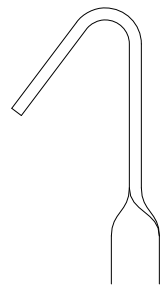
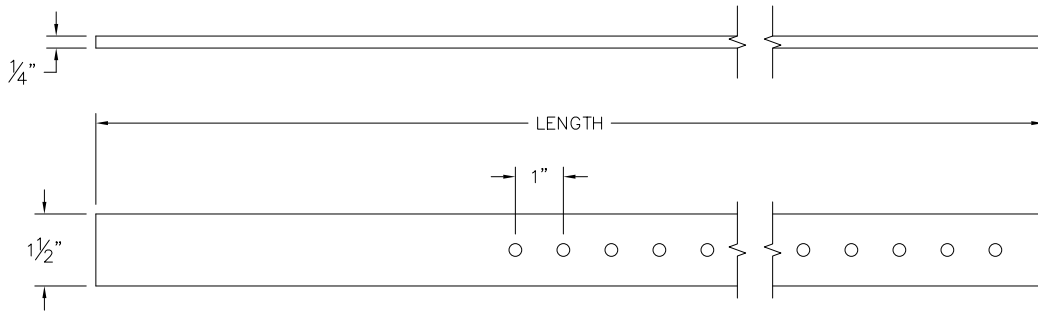

HOOK WITH TWIST

LENGTH	NO HOOK	PLAIN HOOK	HOOK WITH TWIST
30"	AS30-212-NHKK	AS30-212-PHKK	AS30-212-THKH
36"	AS36-212-NHKK	AS36-212-PHKK	AS36-212-THKH
42"	AS42-212-NHKK	AS42-212-PHKK	AS42-212-THKH
48"	AS48-212-NHKK	AS48-212-PHKK	AS48-212-THKH
54"	AS54-212-NHKK	AS54-212-PHKK	AS54-212-THKH
60"	AS60-212-NHKK	AS60-212-PHKK	AS60-212-THKH

- SLOT: 17/64" X 3-1/2"

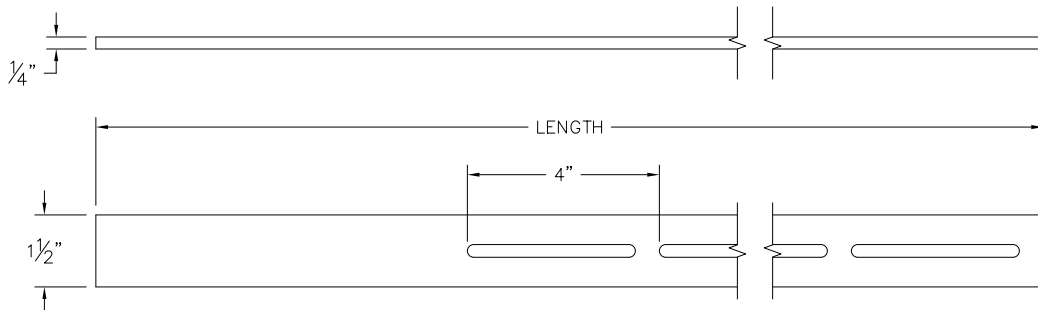

LENGTH	NO HOOK	PLAIN HOOK	HOOK WITH TWIST
30"	AS30-212-NHKS	AS30-212-PHKS	AS30-212-THKS
36"	AS36-212-NHKS	AS36-212-PHKS	AS36-212-THKS
42"	AS42-212-NHKS	AS42-212-PHKS	AS42-212-THKS
48"	AS48-212-NHKS	AS48-212-PHKS	AS48-212-THKS
54"	AS54-212-NHKS	AS54-212-PHKS	AS54-212-THKS
60"	AS60-212-NHKS	AS60-212-PHKS	AS60-212-THKS

3/8" X 1"

HOOK STYLES

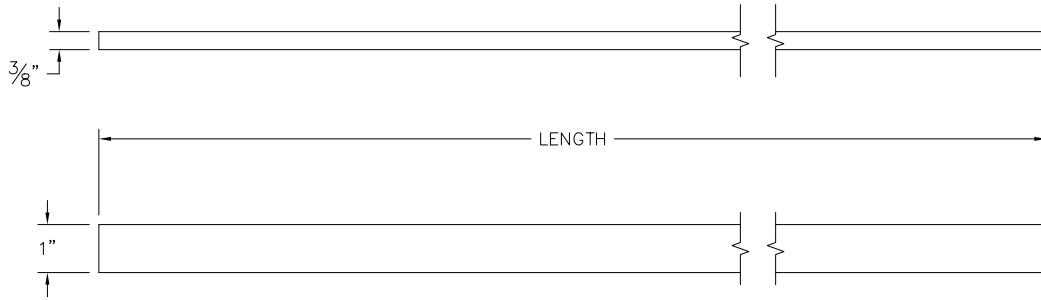

NO HOOK

LENGTH	NO HOOK	PLAIN HOOK	HOOK WITH TWIST
30"	AS30-38-NHK	AS30-38-PHK	AS30-38-THK
36"	AS36-38-NHK	AS36-38-PHK	AS36-38-THK
42"	AS42-38-NHK	AS42-38-PHK	AS42-38-THK
48"	AS48-38-NHK	AS48-38-PHK	AS48-38-THK
54"	AS54-38-NHK	AS54-38-PHK	AS54-38-THK
60"	AS60-38-NHK	AS60-38-PHK	AS60-38-THK

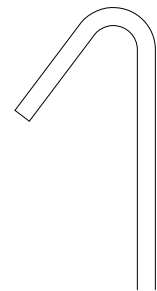

PLAIN HOOK

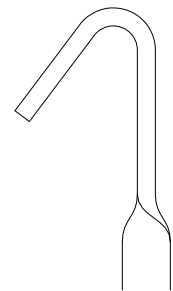

HOOK WITH TWIST

- HOLE: 17/64" DIA.

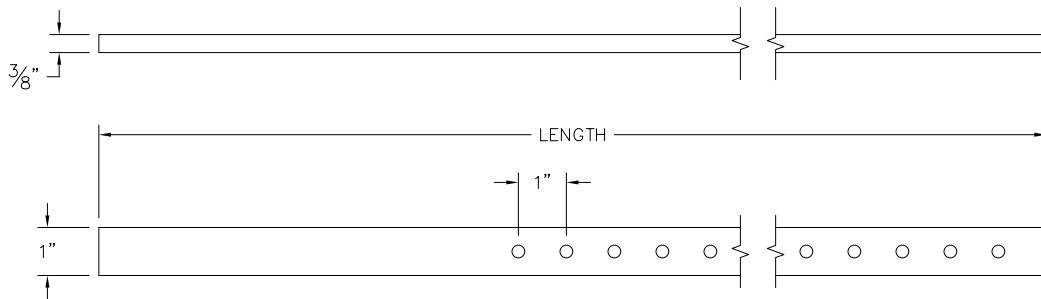

LENGTH	NO HOOK	PLAIN HOOK	HOOK WITH TWIST
30"	AS30-38-NHKK	AS30-38-PHKK	AS30-38-THKH
36"	AS36-38-NHKK	AS36-38-PHKK	AS36-38-THKH
42"	AS42-38-NHKK	AS42-38-PHKK	AS42-38-THKH
48"	AS48-38-NHKK	AS48-38-PHKK	AS48-38-THKH
54"	AS54-38-NHKK	AS54-38-PHKK	AS54-38-THKH
60"	AS60-38-NHKK	AS60-38-PHKK	AS60-38-THKH

- SLOT: 17/64" X 3-1/2"

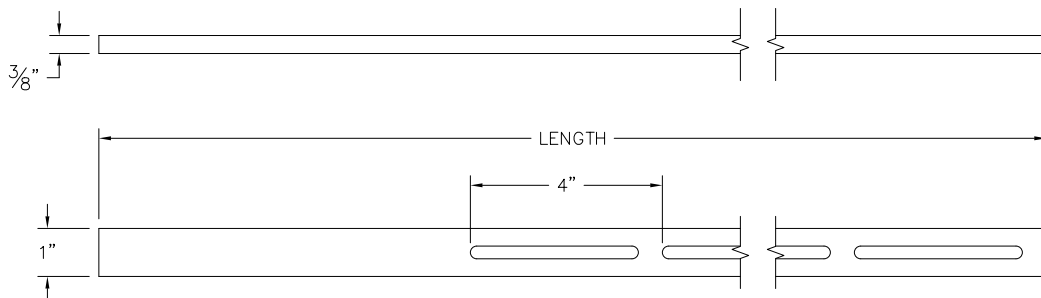

LENGTH	NO HOOK	PLAIN HOOK	HOOK WITH TWIST
30"	AS30-38-NHKS	AS30-38-PHKS	AS30-38-THKS
36"	AS36-38-NHKS	AS36-38-PHKS	AS36-38-THKS
42"	AS42-38-NHKS	AS42-38-PHKS	AS42-38-THKS
48"	AS48-38-NHKS	AS48-38-PHKS	AS48-38-THKS
54"	AS54-38-NHKS	AS54-38-PHKS	AS54-38-THKS
60"	AS60-38-NHKS	AS60-38-PHKS	AS60-38-THKS

ALUMINUM DISCS

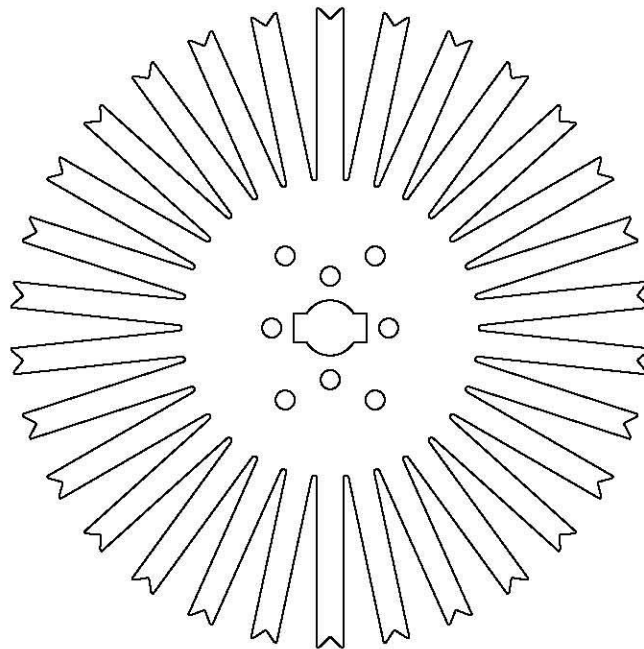

HOLE STYLES

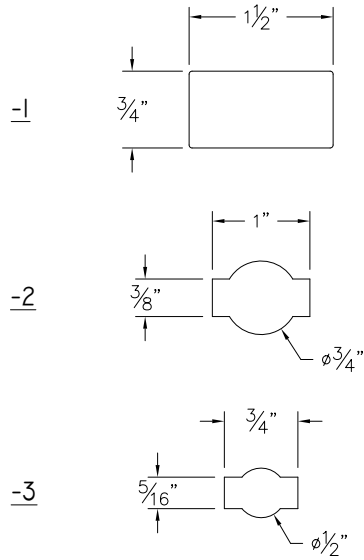

FORM STYLES

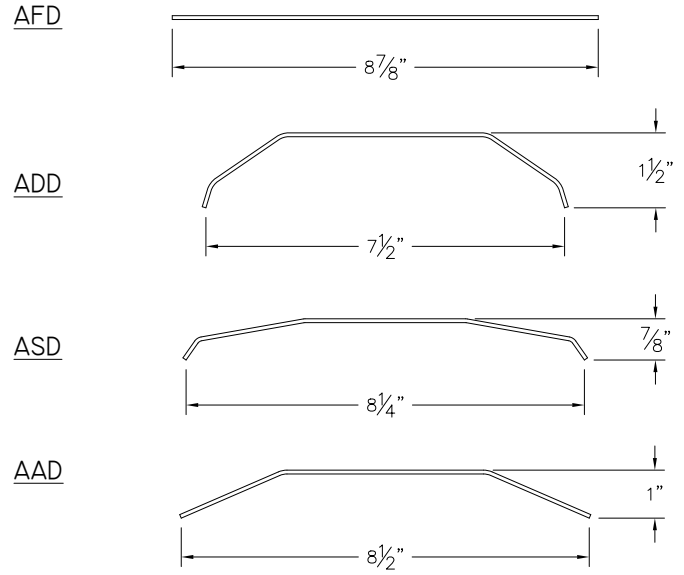

- MATERIAL: 0.080" 6061-T6 ALUMINUM
- 30 FINGERS, 3/8" WIDE
- FINGER HAS 90° NOTCH

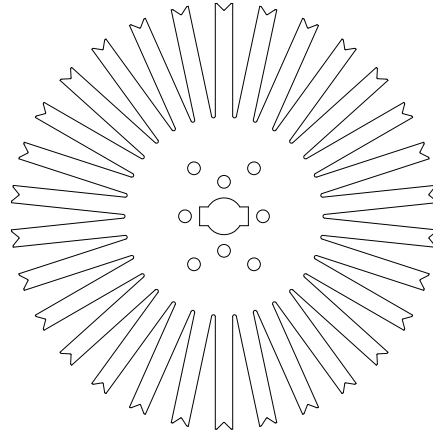

HOLE STYLE	FORM AFD - FLAT	FORM ADD - DEEP DISH	FORM ASD - SHALLOW DISH	FORM AAD - ANGLE DISH
-1	AFD-080-30-1	ADD-080-30-1	ASD-080-30-1	AAD-080-30-1
-2	AFD-080-30-2	ADD-080-30-2	ASD-080-30-2	AAD-080-30-2
-3	AFD-080-30-3	ADD-080-30-3	ASD-080-30-3	AAD-080-30-3

- MATERIAL: 0.080" 6061-T6 ALUMINUM
- 30 FINGERS, 3/8" WIDE
- FINGER HAS 90° POINT

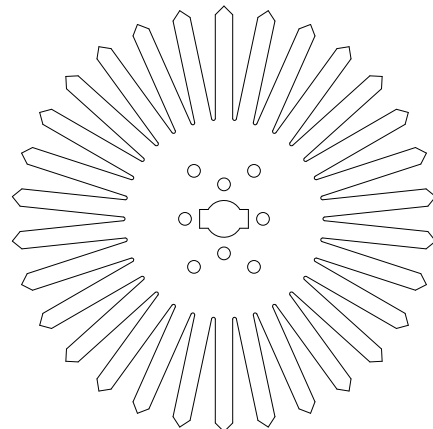

HOLE STYLE	FORM AFD - FLAT	FORM ADD - DEEP DISH	FORM ASD - SHALLOW DISH	FORM AAD - ANGLE DISH
-1	AFD-080-30-P-1	ADD-080-30-P-1	ASD-080-30-P-1	AAD-080-30-P-1
-2	AFD-080-30-P-2	ADD-080-30-P-2	ASD-080-30-P-2	AAD-080-30-P-2
-3	AFD-080-30-P-3	ADD-080-30-P-3	ASD-080-30-P-3	AAD-080-30-P-3

HOLE STYLES

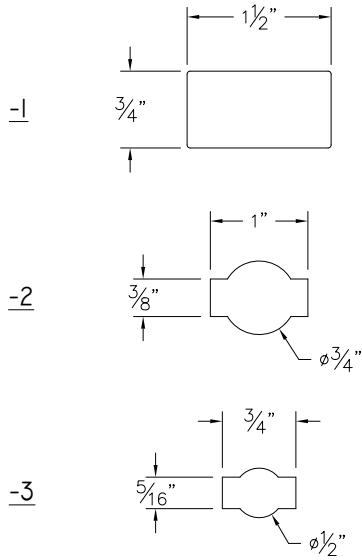

FORM STYLES

AFD

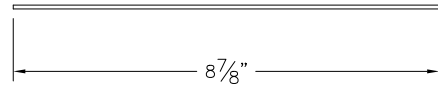

- MATERIAL: 0.080" 6061-T6 ALUMINUM
- 30 FINGERS, 3/8" WIDE
- FINGER HAS 0.175" X 0.500" SLOT

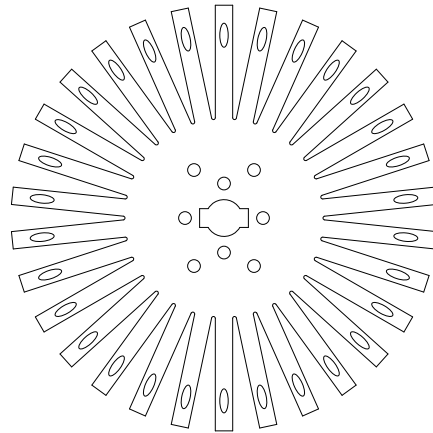

HOLE STYLE	FORM AFD - FLAT
-1	AFD-080-30-1-0.5 SLOTTED
-2	AFD-080-30-2-0.5 SLOTTED
-3	AFD-080-30-3-0.5 SLOTTED

- MATERIAL: 0.080" 6061-T6 ALUMINUM
- 30 FINGERS, 3/8" WIDE
- FINGER HAS 0.175" X 1" SLOT

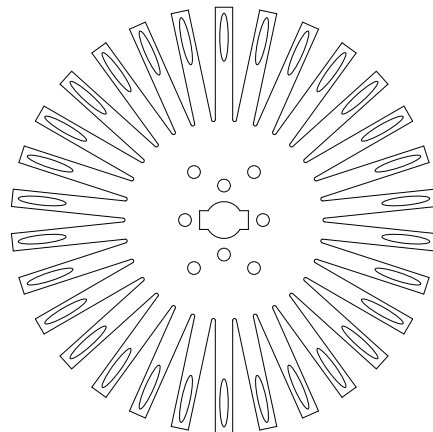

HOLE STYLE	FORM AFD - FLAT
-1	AFD-080-30-1-1.0 SLOTTED
-2	AFD-080-30-2-1.0 SLOTTED
-3	AFD-080-30-3-1.0 SLOTTED

ALUMINUM ANGLES AND COLLARS

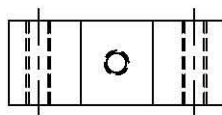
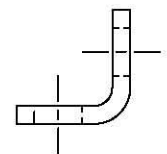
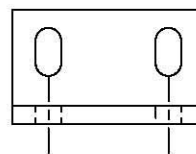
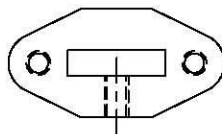
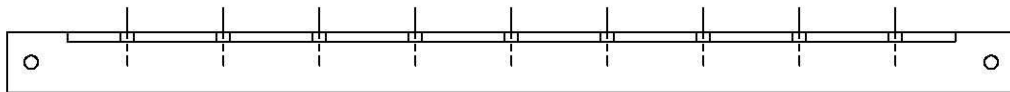
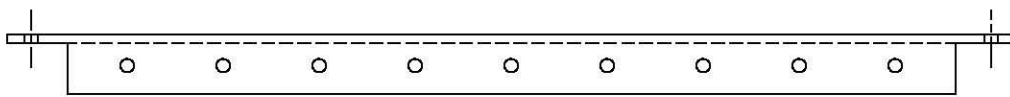

- HOLES: 9/32" DIA.

1-1/4" X 1-1/4" ANGLE

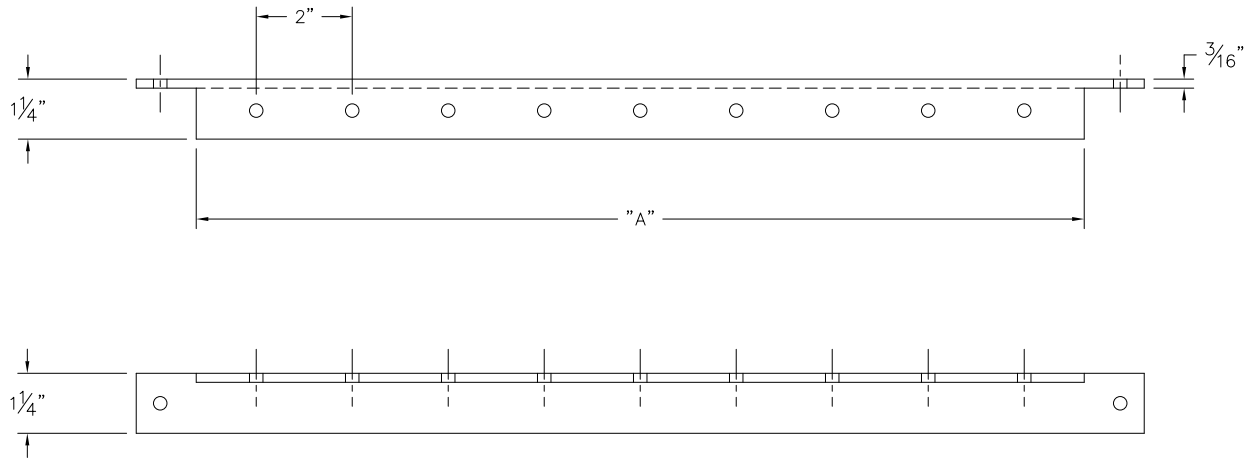

MODEL NO.	"A"
AL-12 ANGLE	12.50"
AL-18 ANGLE	18.50"
AL-24 ANGLE	24.50"
AL-30 ANGLE	30.50"
AL-36 ANGLE	36.50"
AL-48 ANGLE	48.50"

DISC COLLARS

- ALL HOLES TAPPED 1/4-20

- USED WITH 1/4" AND 3/8" THICK SPLINE

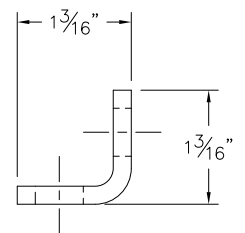
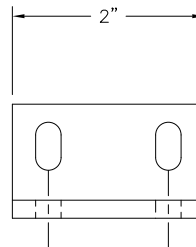
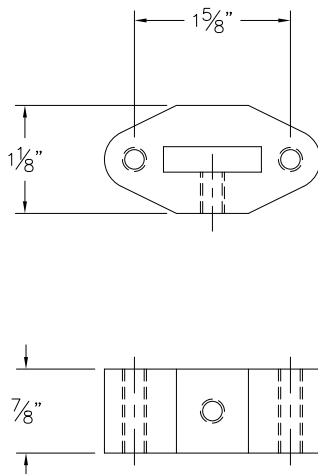

MODEL NO.	SPLINE
AL BLOCK COLLAR 26	1/4" X 3/4"
AL BLOCK COLLAR 28	1/4" X 1"
AL BLOCK COLLAR 38	3/8" X 1"

MODEL NO.
AL DISC BRACKET