

ALUMINUM BOX RACK ASSEMBLY

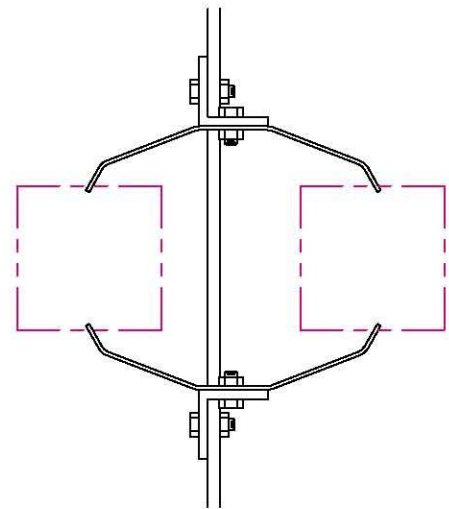

2-Point Contact Assembly

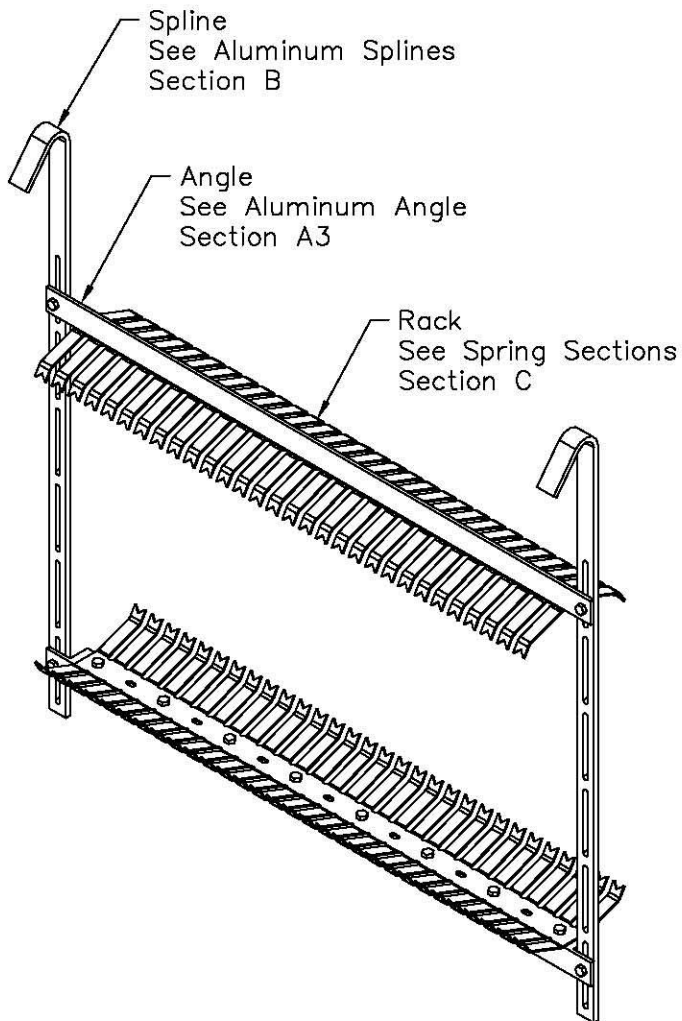
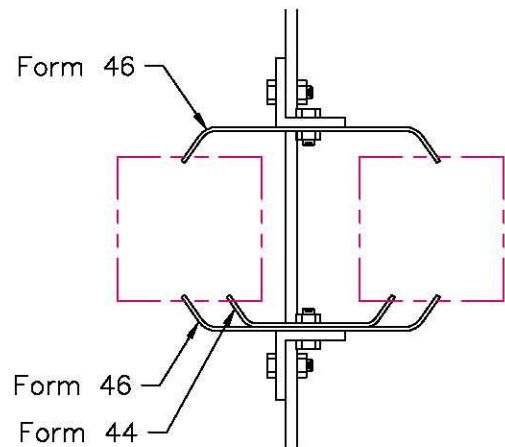

3-Point Contact Assembly

1 / 2" FINGER SPACING

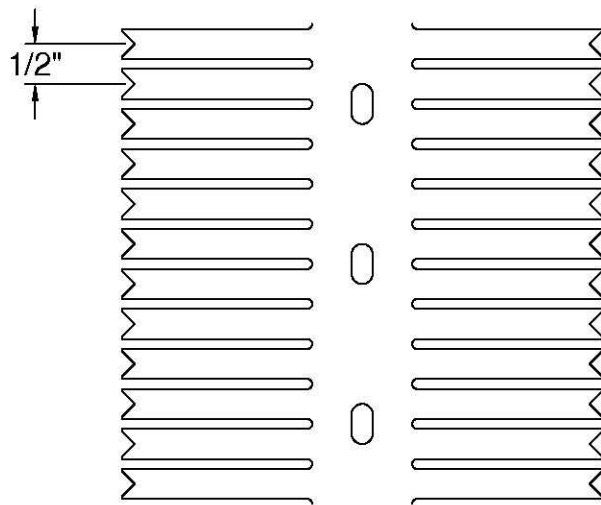

- MATERIAL: 0.080" 6061-T6 ALUMINUM
- HOLE STYLE: 0.265" X 0.500" ON 2" C.L. SPACING
- FINGER HAS 90° NOTCH

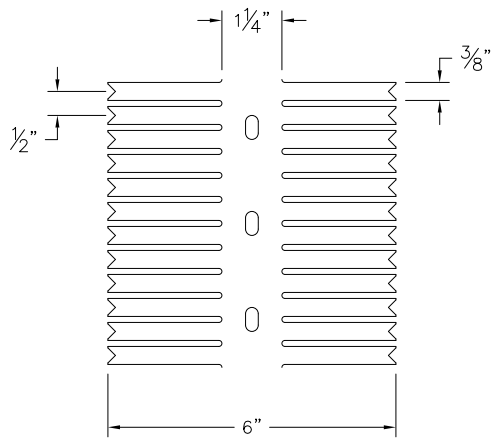

FORM 06 - FLAT

FORM 26

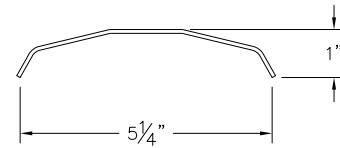

FORM 36

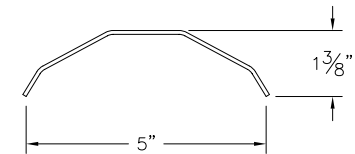

FORM 46

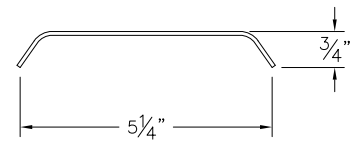

LENGTH	NO. OF FINGERS	FORM 06 - FLAT	FORM 26	FORM 36	FORM 46
18"	72	AL 834-18-N-06-2	AL 834-18-N-26-2	AL 834-18-N-36-2	AL 834-18-N-46-2
24"	96	AL 834-24-N-06-2	AL 834-24-N-26-2	AL 834-24-N-36-2	AL 834-24-N-46-2
30"	120	AL 834-30-N-06-2	AL 834-30-N-26-2	AL 834-30-N-36-2	AL 834-30-N-46-2
36"	144	AL 834-36-N-06-2	AL 834-36-N-26-2	AL 834-36-N-36-2	AL 834-36-N-46-2
48"	192	AL 834-48-N-06-2	AL 834-48-N-26-2	AL 834-48-N-36-2	AL 834-48-N-46-2

- MATERIAL: 0.080" 6061-T6 ALUMINUM
- HOLE STYLE: 0.265" X 0.500" ON 2" C.L. SPACING
- FINGER HAS 90° NOTCH

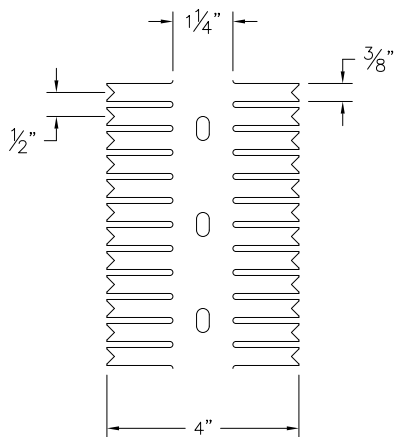

FORM 04 - FLAT

FORM 44

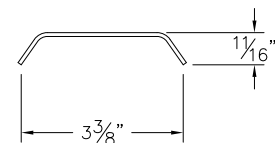

TO BE USED WITH FORM 46
WHEN 3-POINT CONTACT IS REQUIRED

LENGTH	NO. OF FINGERS	FORM 04 - FLAT	FORM 44
18"	72	AL 834-18-N-04-2	AL 834-18-N-44-2
24"	96	AL 834-24-N-04-2	AL 834-24-N-44-2
30"	120	AL 834-30-N-04-2	AL 834-30-N-44-2
36"	144	AL 834-36-N-04-2	AL 834-36-N-44-2
48"	192	AL 834-48-N-04-2	AL 834-48-N-44-2

3/4" FINGER SPACING

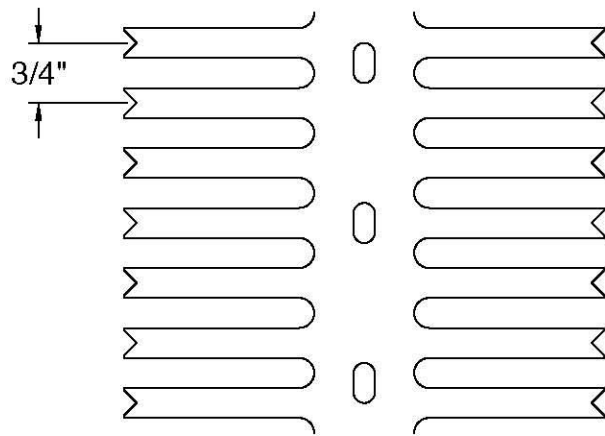

- MATERIAL: 0.080" 6061-T6 ALUMINUM
- HOLE STYLE: 0.265" X 0.500" ON 2" C.L. SPACING
- FINGER HAS 90° NOTCH

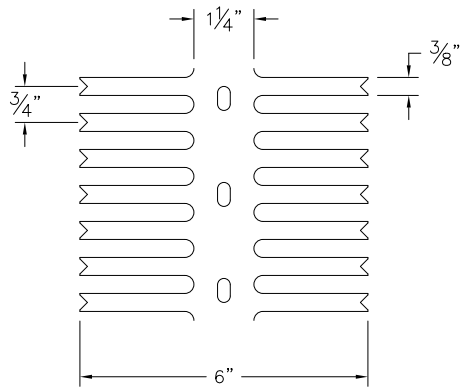

FORM 06 - FLAT

FORM 26

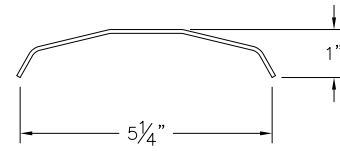

FORM 36

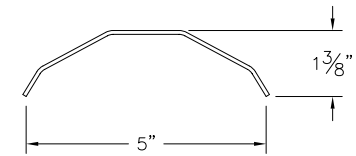

FORM 46

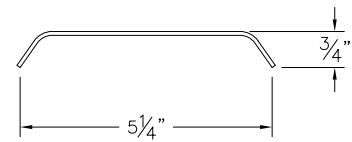

LENGTH	NO. OF FINGERS	FORM 06 - FLAT	FORM 26	FORM 36	FORM 46
18"	48	AL 836-18-N-06-2	AL 836-18-N-26-2	AL 836-18-N-36-2	AL 836-18-N-46-2
24"	64	AL 836-24-N-06-2	AL 836-24-N-26-2	AL 836-24-N-36-2	AL 836-24-N-46-2
30"	80	AL 836-30-N-06-2	AL 836-30-N-26-2	AL 836-30-N-36-2	AL 836-30-N-46-2
36"	96	AL 836-36-N-06-2	AL 836-36-N-26-2	AL 836-36-N-36-2	AL 836-36-N-46-2
48"	128	AL 836-48-N-06-2	AL 836-48-N-26-2	AL 836-48-N-36-2	AL 836-48-N-46-2

- MATERIAL: 0.080" 6061-T6 ALUMINUM
- HOLE STYLE: 0.265" X 0.500" ON 2" C.L. SPACING
- FINGER HAS 30° NOTCH

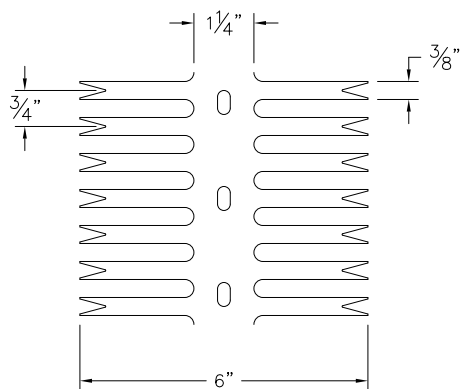

FORM 06 - FLAT

FORM 26

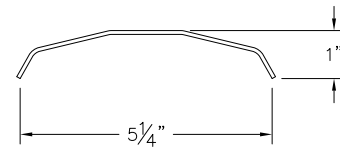

FORM 36

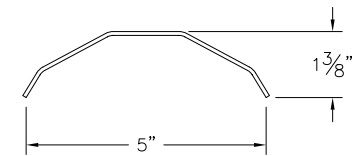

FORM 46

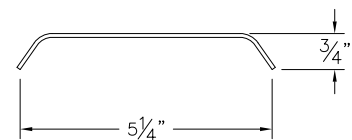

LENGTH	NO. OF FINGERS	FORM 06 - FLAT	FORM 26	FORM 36	FORM 46
18"	48	AL 836-18-T-06-2	AL 836-18-T-26-2	AL 836-18-T-36-2	AL 836-18-T-46-2
24"	64	AL 836-24-T-06-2	AL 836-24-T-26-2	AL 836-24-T-36-2	AL 836-24-T-46-2
30"	80	AL 836-30-T-06-2	AL 836-30-T-26-2	AL 836-30-T-36-2	AL 836-30-T-46-2
36"	96	AL 836-36-T-06-2	AL 836-36-T-26-2	AL 836-36-T-36-2	AL 836-36-T-46-2
48"	128	AL 836-48-T-06-2	AL 836-48-T-26-2	AL 836-48-T-36-2	AL 836-48-T-46-2

- MATERIAL: 0.080" 6061-T6 ALUMINUM
- HOLE STYLE: 0.265" X 0.500" ON 2" C.L. SPACING
- FINGER HAS 90° NOTCH

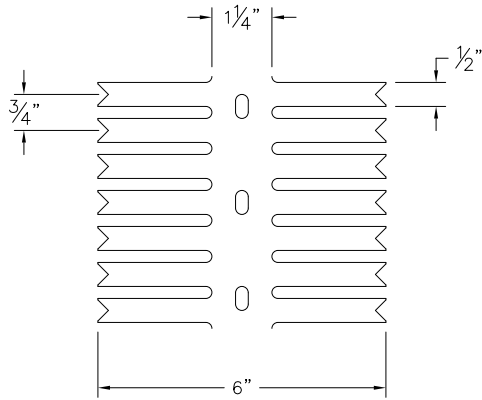

FORM 06 - FLAT

FORM 26

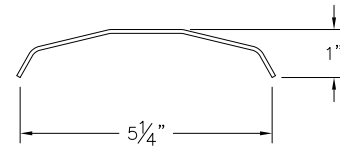

FORM 36

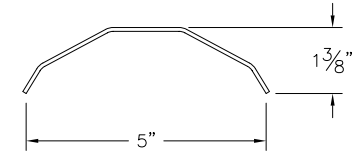

FORM 46

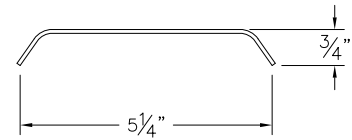

LENGTH	NO. OF FINGERS	FORM 06 - FLAT	FORM 26	FORM 36	FORM 46
18"	48	AL 846-18-N-06-2	AL 846-18-N-26-2	AL 846-18-N-36-2	AL 846-18-N-46-2
24"	64	AL 846-24-N-06-2	AL 846-24-N-26-2	AL 846-24-N-36-2	AL 846-24-N-46-2
30"	80	AL 846-30-N-06-2	AL 846-30-N-26-2	AL 846-30-N-36-2	AL 846-30-N-46-2
36"	96	AL 846-36-N-06-2	AL 846-36-N-26-2	AL 846-36-N-36-2	AL 846-36-N-46-2
48"	128	AL 846-48-N-06-2	AL 846-48-N-26-2	AL 846-48-N-36-2	AL 846-48-N-46-2

- MATERIAL: 0.080" 6061-T6 ALUMINUM
- HOLE STYLE: 0.265" X 0.500" ON 2" C.L. SPACING
- FINGER HAS 90° NOTCH

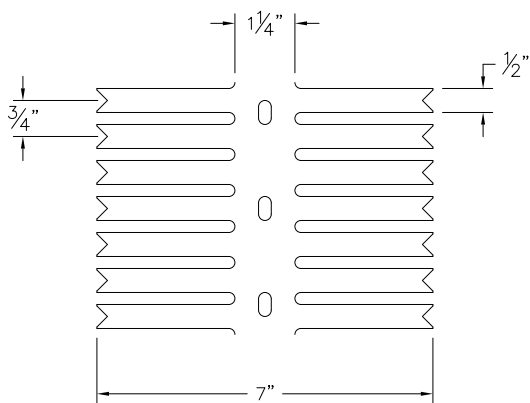

FORM 07 - FLAT

FORM 27

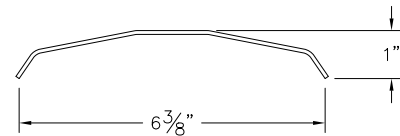

FORM 37

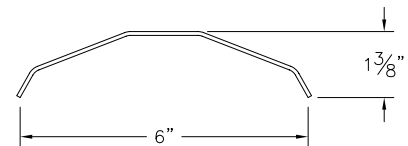

FORM 47

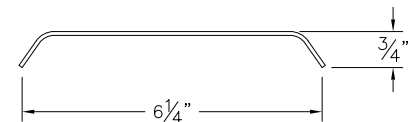

LENGTH	NO. OF FINGERS	FORM 07 - FLAT	FORM 27	FORM 37	FORM 47
18"	48	AL 846-18-N-07-2	AL 846-18-N-27-2	AL 846-18-N-37-2	AL 846-18-N-47-2
24"	64	AL 846-24-N-07-2	AL 846-24-N-27-2	AL 846-24-N-37-2	AL 846-24-N-47-2
30"	80	AL 846-30-N-07-2	AL 846-30-N-27-2	AL 846-30-N-37-2	AL 846-30-N-47-2
36"	96	AL 846-36-N-07-2	AL 846-36-N-27-2	AL 846-36-N-37-2	AL 846-36-N-47-2
48"	128	AL 846-48-N-07-2	AL 846-48-N-27-2	AL 846-48-N-37-2	AL 846-48-N-47-2

- MATERIAL: 0.080" 6061-T6 ALUMINUM
- HOLE STYLE: 0.265" X 0.500" ON 2" C.L. SPACING
- FINGER HAS 30° NOTCH

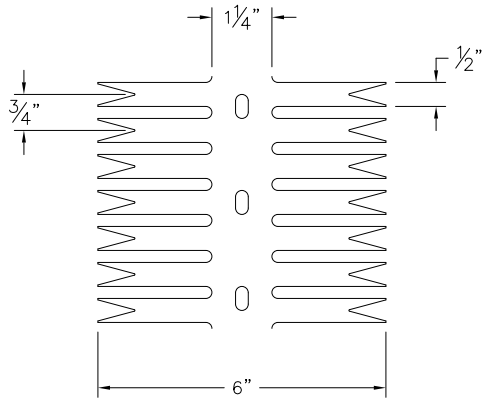

FORM 06 - FLAT

FORM 26

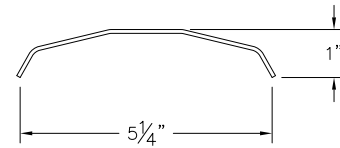

FORM 36

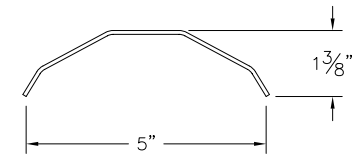

FORM 46

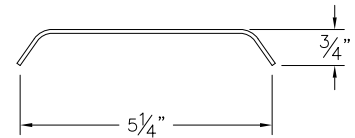

LENGTH	NO. OF FINGERS	FORM 06 - FLAT	FORM 26	FORM 36	FORM 46
18"	48	AL 846-18-T-06-2	AL 846-18-T-26-2	AL 846-18-T-36-2	AL 846-18-T-46-2
24"	64	AL 846-24-T-06-2	AL 846-24-T-26-2	AL 846-24-T-36-2	AL 846-24-T-46-2
30"	80	AL 846-30-T-06-2	AL 846-30-T-26-2	AL 846-30-T-36-2	AL 846-30-T-46-2
36"	96	AL 846-36-T-06-2	AL 846-36-T-26-2	AL 846-36-T-36-2	AL 846-36-T-46-2
48"	128	AL 846-48-T-06-2	AL 846-48-T-26-2	AL 846-48-T-36-2	AL 846-48-T-46-2

- MATERIAL: 0.080" 6061-T6 ALUMINUM
- HOLE STYLE: 0.265" X 0.500" ON 2" C.L. SPACING
- FINGER HAS 30° NOTCH

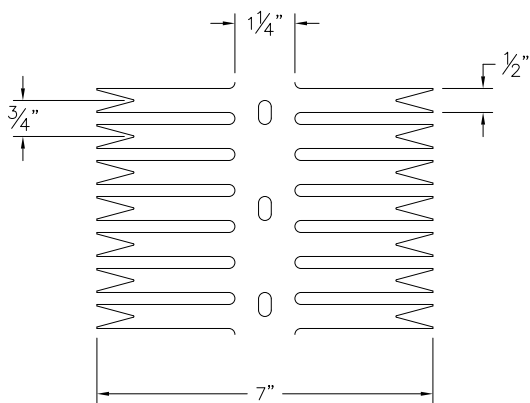

FORM 07 - FLAT

FORM 27

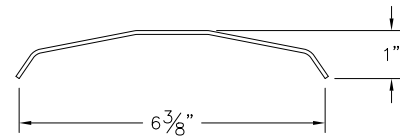

FORM 37

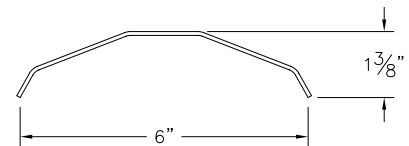

FORM 47

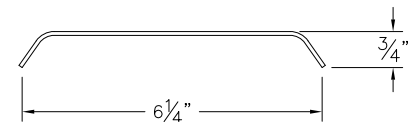

LENGTH	NO. OF FINGERS	FORM 07 - FLAT	FORM 27	FORM 37	FORM 47
18"	48	AL 846-18-T-07-2	AL 846-18-T-27-2	AL 846-18-T-37-2	AL 846-18-T-47-2
24"	64	AL 846-24-T-07-2	AL 846-24-T-27-2	AL 846-24-T-37-2	AL 846-24-T-47-2
30"	80	AL 846-30-T-07-2	AL 846-30-T-27-2	AL 846-30-T-37-2	AL 846-30-T-47-2
36"	96	AL 846-36-T-07-2	AL 846-36-T-27-2	AL 846-36-T-37-2	AL 846-36-T-47-2
48"	128	AL 846-48-T-07-2	AL 846-48-T-27-2	AL 846-48-T-37-2	AL 846-48-T-47-2

- MATERIAL: 0.080" 6061-T6 ALUMINUM
- HOLE STYLE: 0.265" X 0.500" ON 2" C.L. SPACING
- FINGER HAS 90° NOTCH

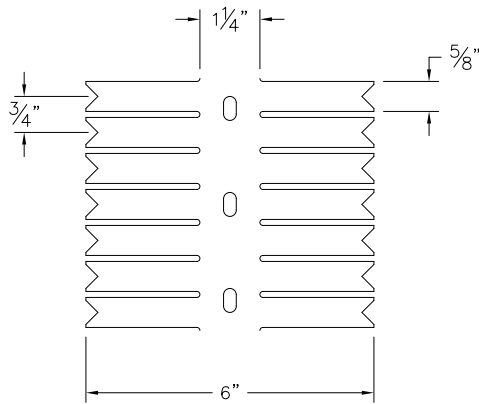

FORM 06 - FLAT

FORM 26

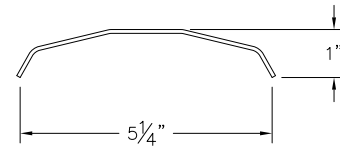

FORM 36

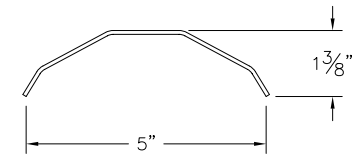

FORM 46

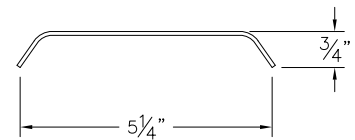

LENGTH	NO. OF FINGERS	FORM 06 - FLAT	FORM 26	FORM 36	FORM 46
18"	48	AL 856-18-N-06-2	AL 856-18-N-26-2	AL 856-18-N-36-2	AL 856-18-N-46-2
24"	64	AL 856-24-N-06-2	AL 856-24-N-26-2	AL 856-24-N-36-2	AL 856-24-N-46-2
30"	80	AL 856-30-N-06-2	AL 856-30-N-26-2	AL 856-30-N-36-2	AL 856-30-N-46-2
36"	96	AL 856-36-N-06-2	AL 856-36-N-26-2	AL 856-36-N-36-2	AL 856-36-N-46-2
48"	128	AL 856-48-N-06-2	AL 856-48-N-26-2	AL 856-48-N-36-2	AL 856-48-N-46-2

- MATERIAL: 0.080" 6061-T6 ALUMINUM
- HOLE STYLE: 0.265" X 0.500" ON 2" C.L. SPACING
- FINGER HAS 90° NOTCH

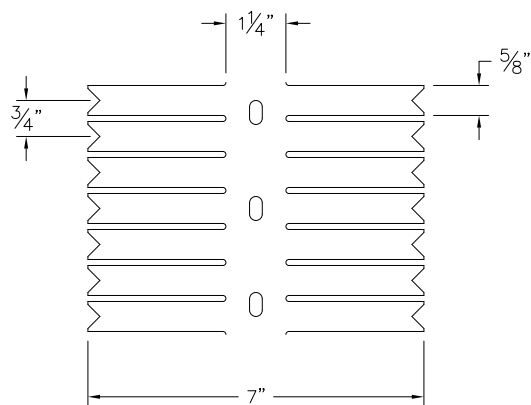

FORM 07 - FLAT

FORM 27

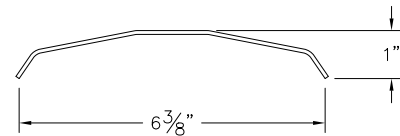

FORM 37

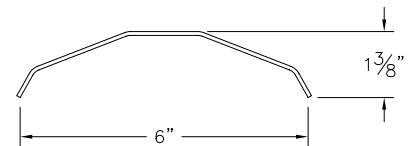

FORM 47

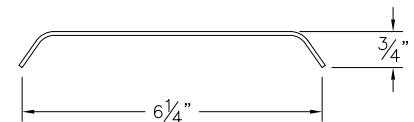

LENGTH	NO. OF FINGERS	FORM 07 - FLAT	FORM 27	FORM 37	FORM 47
18"	48	AL 856-18-N-07-2	AL 856-18-N-27-2	AL 856-18-N-37-2	AL 856-18-N-47-2
24"	64	AL 856-24-N-07-2	AL 856-24-N-27-2	AL 856-24-N-37-2	AL 856-24-N-47-2
30"	80	AL 856-30-N-07-2	AL 856-30-N-27-2	AL 856-30-N-37-2	AL 856-30-N-47-2
36"	96	AL 856-36-N-07-2	AL 856-36-N-27-2	AL 856-36-N-37-2	AL 856-36-N-47-2
48"	128	AL 856-48-N-07-2	AL 856-48-N-27-2	AL 856-48-N-37-2	AL 856-48-N-47-2

- MATERIAL: 0.080" 6061-T6 ALUMINUM
- HOLE STYLE: 0.265" X 0.500" ON 2" C.L. SPACING
- FINGER HAS 30° NOTCH

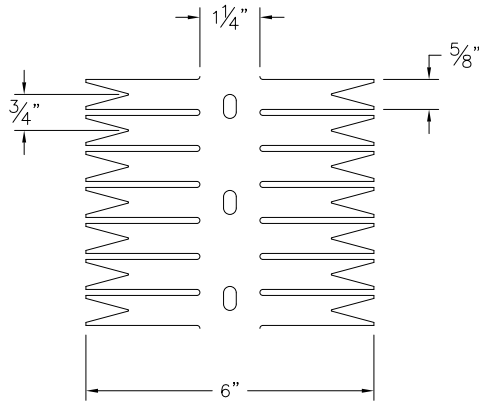

FORM 06 - FLAT

FORM 26

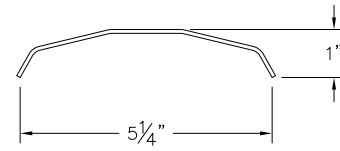

FORM 36

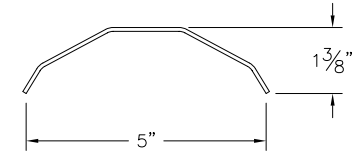

FORM 46

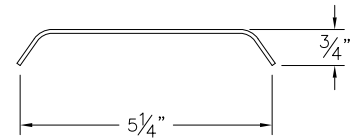

LENGTH	NO. OF FINGERS	FORM 06 - FLAT	FORM 26	FORM 36	FORM 46
18"	48	AL 856-18-T-06-2	AL 856-18-T-26-2	AL 856-18-T-36-2	AL 856-18-T-46-2
24"	64	AL 856-24-T-06-2	AL 856-24-T-26-2	AL 856-24-T-36-2	AL 856-24-T-46-2
30"	80	AL 856-30-T-06-2	AL 856-30-T-26-2	AL 856-30-T-36-2	AL 856-30-T-46-2
36"	96	AL 856-36-T-06-2	AL 856-36-T-26-2	AL 856-36-T-36-2	AL 856-36-T-46-2
48"	128	AL 856-48-T-06-2	AL 856-48-T-26-2	AL 856-48-T-36-2	AL 856-48-T-46-2

- MATERIAL: 0.080" 6061-T6 ALUMINUM
- HOLE STYLE: 0.265" X 0.500" ON 2" C.L. SPACING
- FINGER HAS 30° NOTCH

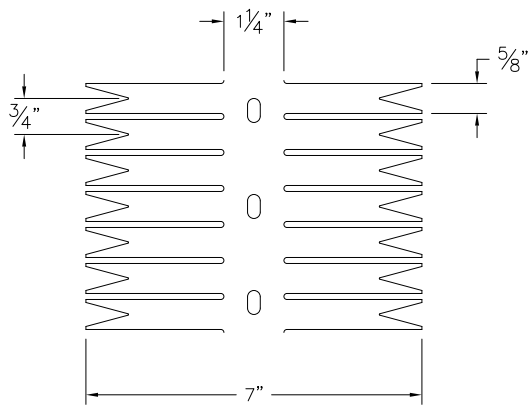

FORM 07 - FLAT

FORM 27

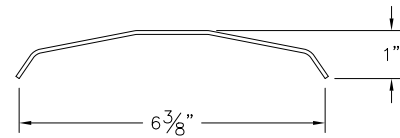

FORM 37

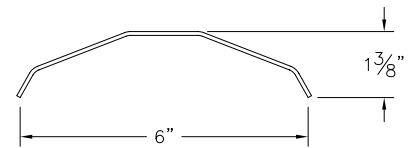

FORM 47

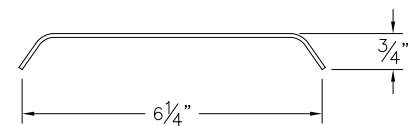

LENGTH	NO. OF FINGERS	FORM 07 - FLAT	FORM 27	FORM 37	FORM 47
18"	48	AL 856-18-T-07-2	AL 856-18-T-27-2	AL 856-18-T-37-2	AL 856-18-T-47-2
24"	64	AL 856-24-T-07-2	AL 856-24-T-27-2	AL 856-24-T-37-2	AL 856-24-T-47-2
30"	80	AL 856-30-T-07-2	AL 856-30-T-27-2	AL 856-30-T-37-2	AL 856-30-T-47-2
36"	96	AL 856-36-T-07-2	AL 856-36-T-27-2	AL 856-36-T-37-2	AL 856-36-T-47-2
48"	128	AL 856-48-T-07-2	AL 856-48-T-27-2	AL 856-48-T-37-2	AL 856-48-T-47-2

1" FINGER SPACING

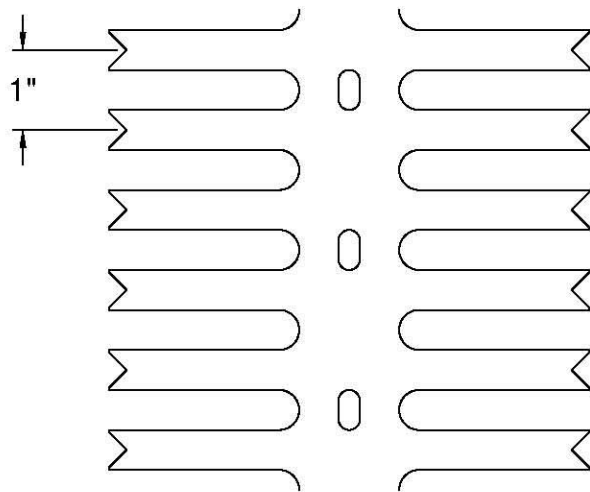

- MATERIAL: 0.080" 6061-T6 ALUMINUM
- HOLE STYLE: 0.265" X 0.500" ON 2" C.L. SPACING
- FINGER HAS 90° NOTCH

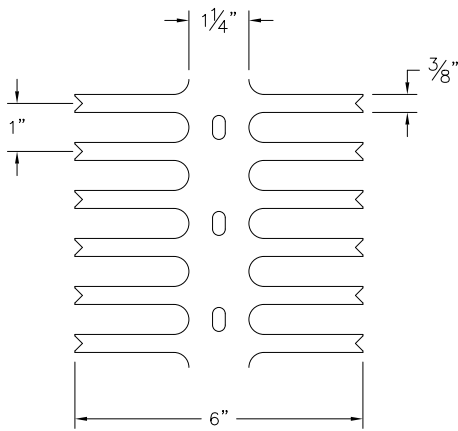

FORM 06 - FLAT

FORM 26

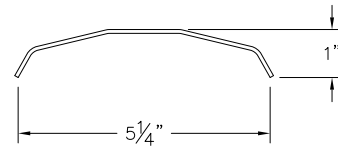

FORM 36

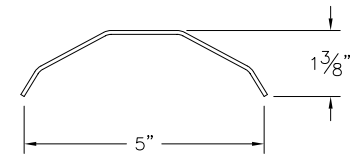

FORM 46

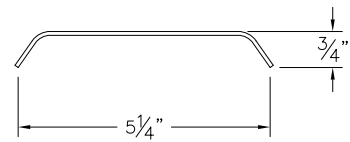

LENGTH	NO. OF FINGERS	FORM 06 - FLAT	FORM 26	FORM 36	FORM 46
18"	36	AL 838-18-N-06-2	AL 838-18-N-26-2	AL 838-18-N-36-2	AL 838-18-N-46-2
24"	48	AL 838-24-N-06-2	AL 838-24-N-26-2	AL 838-24-N-36-2	AL 838-24-N-46-2
30"	60	AL 838-30-N-06-2	AL 838-30-N-26-2	AL 838-30-N-36-2	AL 838-30-N-46-2
36"	72	AL 838-36-N-06-2	AL 838-36-N-26-2	AL 838-36-N-36-2	AL 838-36-N-46-2
48"	96	AL 838-48-N-06-2	AL 838-48-N-26-2	AL 838-48-N-36-2	AL 838-48-N-46-2

- MATERIAL: 0.080" 6061-T6 ALUMINUM
- HOLE STYLE: 0.265" X 0.500" ON 2" C.L. SPACING
- FINGER HAS 30° NOTCH

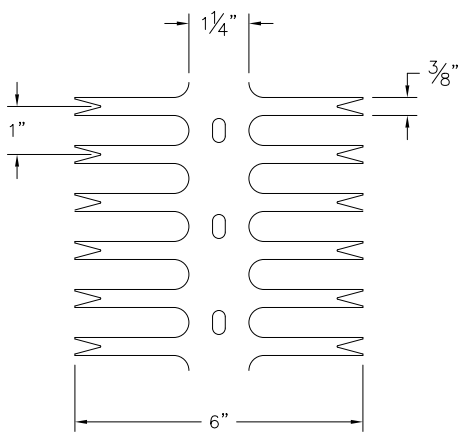

FORM 06 - FLAT

FORM 27

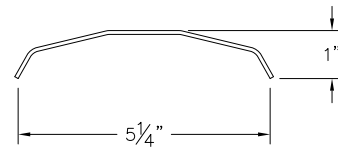

FORM 37

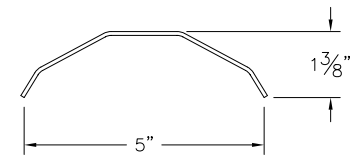

FORM 47

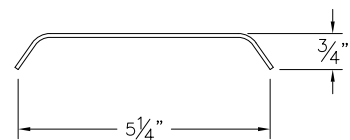

LENGTH	NO. OF FINGERS	FORM 06 - FLAT	FORM 26	FORM 36	FORM 46
18"	36	AL 838-18-T-06-2	AL 838-18-T-26-2	AL 838-18-T-36-2	AL 838-18-T-46-2
24"	48	AL 838-24-T-06-2	AL 838-24-T-26-2	AL 838-24-T-36-2	AL 838-24-T-46-2
30"	60	AL 838-30-T-06-2	AL 838-30-T-26-2	AL 838-30-T-36-2	AL 838-30-T-46-2
36"	72	AL 838-36-T-06-2	AL 838-36-T-26-2	AL 838-36-T-36-2	AL 838-36-T-46-2
48"	96	AL 838-48-T-06-2	AL 838-48-T-26-2	AL 838-48-T-36-2	AL 838-48-T-46-2

- MATERIAL: 0.080" 6061-T6 ALUMINUM
- HOLE STYLE: 0.265" X 0.500" ON 2" C.L. SPACING
- FINGER HAS 90° NOTCH

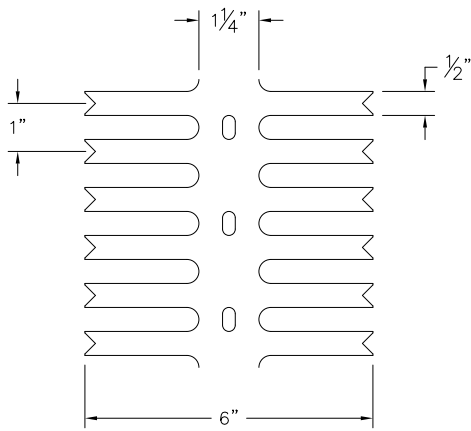

FORM 06 - FLAT

FORM 26

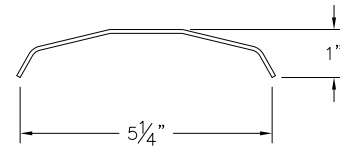

FORM 36

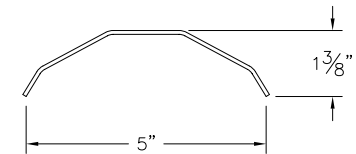

FORM 46

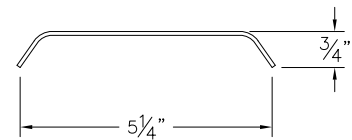

LENGTH	NO. OF FINGERS	FORM 06 - FLAT	FORM 26	FORM 36	FORM 46
18"	36	AL 848-18-N-06-2	AL 848-18-N-26-2	AL 848-18-N-36-2	AL 848-18-N-46-2
24"	48	AL 848-24-N-06-2	AL 848-24-N-26-2	AL 848-24-N-36-2	AL 848-24-N-46-2
30"	60	AL 848-30-N-06-2	AL 848-30-N-26-2	AL 848-30-N-36-2	AL 848-30-N-46-2
36"	72	AL 848-36-N-06-2	AL 848-36-N-26-2	AL 848-36-N-36-2	AL 848-36-N-46-2
48"	96	AL 848-48-N-06-2	AL 848-48-N-26-2	AL 848-48-N-36-2	AL 848-48-N-46-2

- MATERIAL: 0.080" 6061-T6 ALUMINUM
- HOLE STYLE: 0.265" X 0.500" ON 2" C.L. SPACING
- FINGER HAS 90° NOTCH

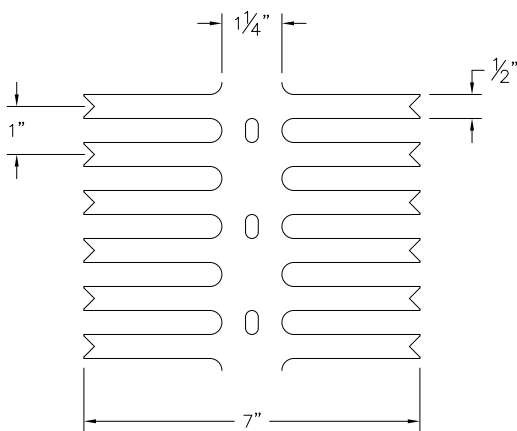

FORM 07 - FLAT

FORM 27

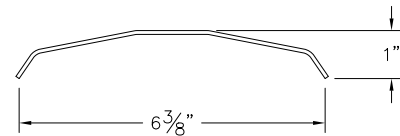

FORM 37

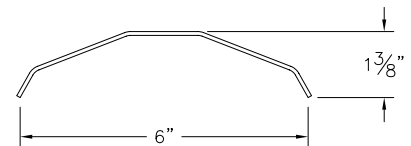

FORM 47

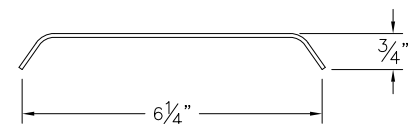

LENGTH	NO. OF FINGERS	FORM 07 - FLAT	FORM 27	FORM 37	FORM 47
18"	36	AL 848-18-N-07-2	AL 848-18-N-27-2	AL 848-18-N-37-2	AL 848-18-N-47-2
24"	48	AL 848-24-N-07-2	AL 848-24-N-27-2	AL 848-24-N-37-2	AL 848-24-N-47-2
30"	60	AL 848-30-N-07-2	AL 848-30-N-27-2	AL 848-30-N-37-2	AL 848-30-N-47-2
36"	72	AL 848-36-N-07-2	AL 848-36-N-27-2	AL 848-36-N-37-2	AL 848-36-N-47-2
48"	96	AL 848-48-N-07-2	AL 848-48-N-27-2	AL 848-48-N-37-2	AL 848-48-N-47-2

- MATERIAL: 0.080" 6061-T6 ALUMINUM
- HOLE STYLE: 0.265" X 0.500" ON 2" C.L. SPACING
- FINGER HAS 30° NOTCH

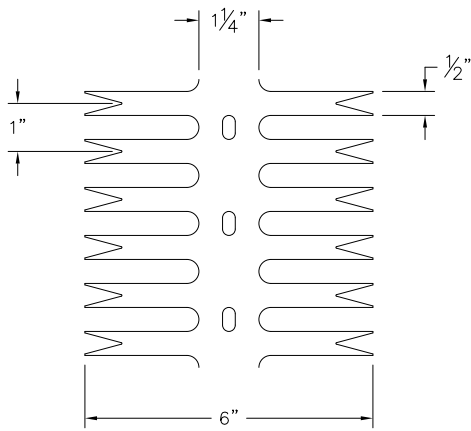

FORM 06 - FLAT

FORM 26

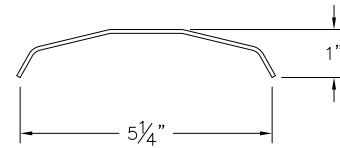

FORM 36

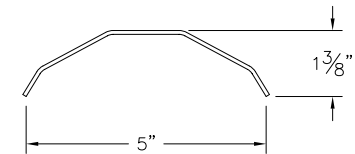

FORM 46

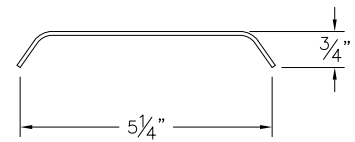

LENGTH	NO. OF FINGERS	FORM 06 - FLAT	FORM 26	FORM 36	FORM 46
18"	36	AL 848-18-T-06-2	AL 848-18-T-26-2	AL 848-18-T-36-2	AL 848-18-T-46-2
24"	48	AL 848-24-T-06-2	AL 848-24-T-26-2	AL 848-24-T-36-2	AL 848-24-T-46-2
30"	60	AL 848-30-T-06-2	AL 848-30-T-26-2	AL 848-30-T-36-2	AL 848-30-T-46-2
36"	72	AL 848-36-T-06-2	AL 848-36-T-26-2	AL 848-36-T-36-2	AL 848-36-T-46-2
48"	96	AL 848-48-T-06-2	AL 848-48-T-26-2	AL 848-48-T-36-2	AL 848-48-T-46-2

- MATERIAL: 0.080" 6061-T6 ALUMINUM
- HOLE STYLE: 0.265" X 0.500" ON 2" C.L. SPACING
- FINGER HAS 30° NOTCH

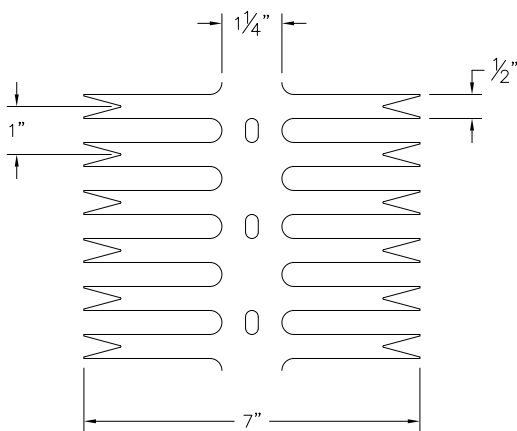

FORM 07 - FLAT

FORM 27

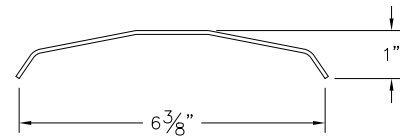

FORM 37

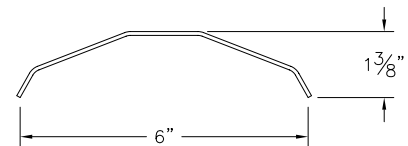

FORM 47

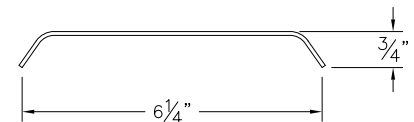

LENGTH	NO. OF FINGERS	FORM 07 - FLAT	FORM 27	FORM 37	FORM 47
18"	36	AL 848-18-T-07-2	AL 848-18-T-27-2	AL 848-18-T-37-2	AL 848-18-T-47-2
24"	48	AL 848-24-T-07-2	AL 848-24-T-27-2	AL 848-24-T-37-2	AL 848-24-T-47-2
30"	60	AL 848-30-T-07-2	AL 848-30-T-27-2	AL 848-30-T-37-2	AL 848-30-T-47-2
36"	72	AL 848-36-T-07-2	AL 848-36-T-27-2	AL 848-36-T-37-2	AL 848-36-T-47-2
48"	96	AL 848-48-T-07-2	AL 848-48-T-27-2	AL 848-48-T-37-2	AL 848-48-T-47-2

- MATERIAL: 0.080" 6061-T6 ALUMINUM
- HOLE STYLE: 0.265" X 0.500" ON 2" C.L. SPACING
- FINGER HAS 90° NOTCH

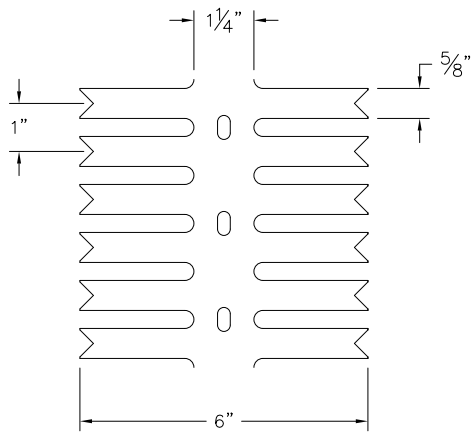

FORM 06 - FLAT

FORM 26

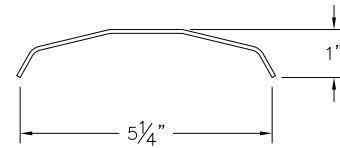

FORM 36

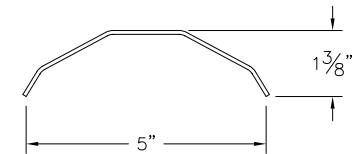

FORM 46

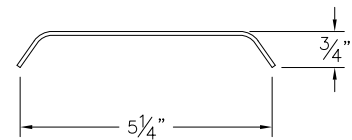

LENGTH	NO. OF FINGERS	FORM 06 - FLAT	FORM 26	FORM 36	FORM 46
18"	36	AL 858-18-N-06-2	AL 858-18-N-26-2	AL 858-18-N-36-2	AL 858-18-N-46-2
24"	48	AL 858-24-N-06-2	AL 858-24-N-26-2	AL 858-24-N-36-2	AL 858-24-N-46-2
30"	60	AL 858-30-N-06-2	AL 858-30-N-26-2	AL 858-30-N-36-2	AL 858-30-N-46-2
36"	72	AL 858-36-N-06-2	AL 858-36-N-26-2	AL 858-36-N-36-2	AL 858-36-N-46-2
48"	96	AL 858-48-N-06-2	AL 858-48-N-26-2	AL 858-48-N-36-2	AL 858-48-N-46-2

- MATERIAL: 0.080" 6061-T6 ALUMINUM
- HOLE STYLE: 0.265" X 0.500" ON 2" C.L. SPACING
- FINGER HAS 90° NOTCH

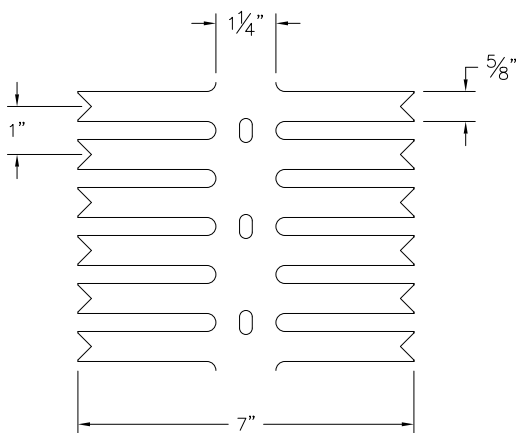

FORM 07 - FLAT

FORM 27

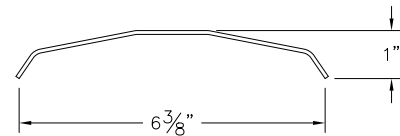

FORM 37

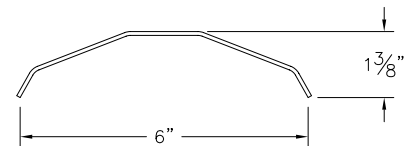

FORM 47

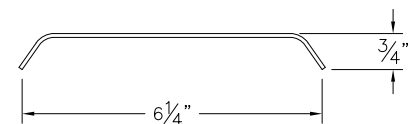

LENGTH	NO. OF FINGERS	FORM 06 - FLAT	FORM 26	FORM 36	FORM 46
18"	36	AL 858-18-N-07-2	AL 858-18-N-27-2	AL 858-18-N-37-2	AL 858-18-N-47-2
24"	48	AL 858-24-N-07-2	AL 858-24-N-27-2	AL 858-24-N-37-2	AL 858-24-N-47-2
30"	60	AL 858-30-N-07-2	AL 858-30-N-27-2	AL 858-30-N-37-2	AL 858-30-N-47-2
36"	72	AL 858-36-N-07-2	AL 858-36-N-27-2	AL 858-36-N-37-2	AL 858-36-N-47-2
48"	96	AL 858-48-N-07-2	AL 858-48-N-27-2	AL 858-48-N-37-2	AL 858-48-N-47-2

- MATERIAL: 0.080" 6061-T6 ALUMINUM
- HOLE STYLE: 0.265" X 0.500" ON 2" C.L. SPACING
- FINGER HAS 30° NOTCH

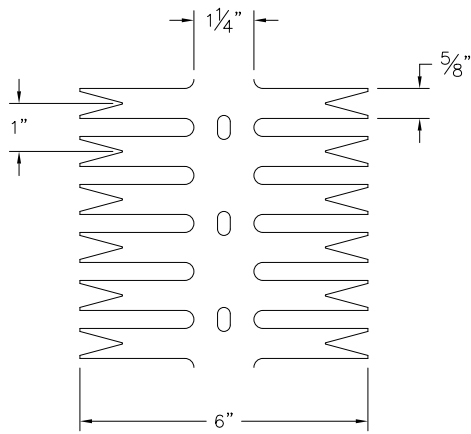

FORM 06 - FLAT

FORM 26

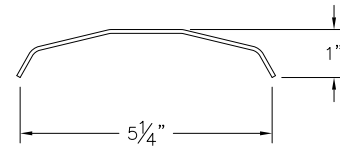

FORM 36

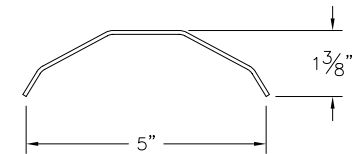

FORM 46

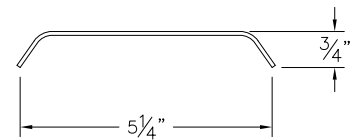

LENGTH	NO. OF FINGERS	FORM 06 - FLAT	FORM 26	FORM 36	FORM 46
18"	36	AL 858-18-T-06-2	AL 858-18-T-26-2	AL 858-18-T-36-2	AL 858-18-T-46-2
24"	48	AL 858-24-T-06-2	AL 858-24-T-26-2	AL 858-24-T-36-2	AL 858-24-T-46-2
30"	60	AL 858-30-T-06-2	AL 858-30-T-26-2	AL 858-30-T-36-2	AL 858-30-T-46-2
36"	72	AL 858-36-T-06-2	AL 858-36-T-26-2	AL 858-36-T-36-2	AL 858-36-T-46-2
48"	96	AL 858-48-T-06-2	AL 858-48-T-26-2	AL 858-48-T-36-2	AL 858-48-T-46-2

- MATERIAL: 0.080" 6061-T6 ALUMINUM
- HOLE STYLE: 0.265" X 0.500" ON 2" C.L. SPACING
- FINGER HAS 30° NOTCH

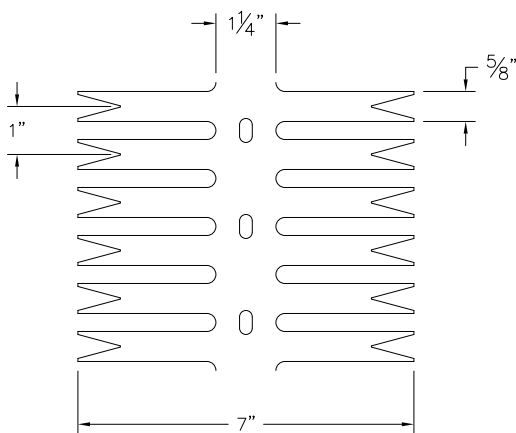

FORM 07 - FLAT

FORM 27

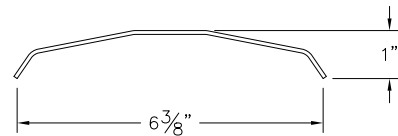

FORM 37

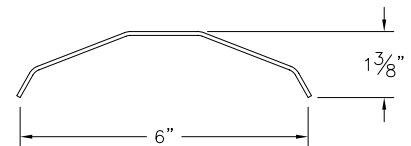

FORM 47

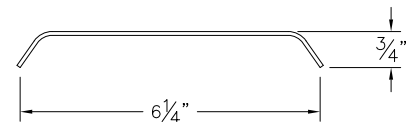

LENGTH	NO. OF FINGERS	FORM 06 - FLAT	FORM 26	FORM 36	FORM 46
18"	36	AL 858-18-T-07-2	AL 858-18-T-27-2	AL 858-18-T-37-2	AL 858-18-T-47-2
24"	48	AL 858-24-T-07-2	AL 858-24-T-27-2	AL 858-24-T-37-2	AL 858-24-T-47-2
30"	60	AL 858-30-T-07-2	AL 858-30-T-27-2	AL 858-30-T-37-2	AL 858-30-T-47-2
36"	72	AL 858-36-T-07-2	AL 858-36-T-27-2	AL 858-36-T-37-2	AL 858-36-T-47-2
48"	96	AL 858-48-T-07-2	AL 858-48-T-27-2	AL 858-48-T-37-2	AL 858-48-T-47-2

1 1/8" FINGER SPACING

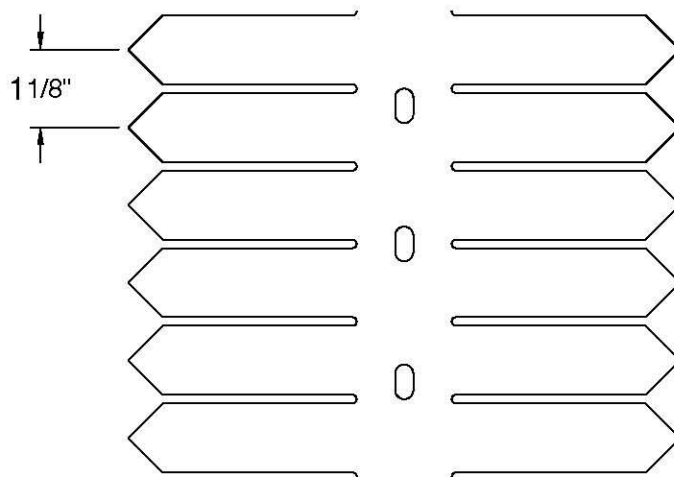

- MATERIAL: 0.080" 6061-T6 ALUMINUM
- HOLE STYLE: 0.265" X 0.500" ON 2" C.L. SPACING
- FINGER HAS SHARP TIP

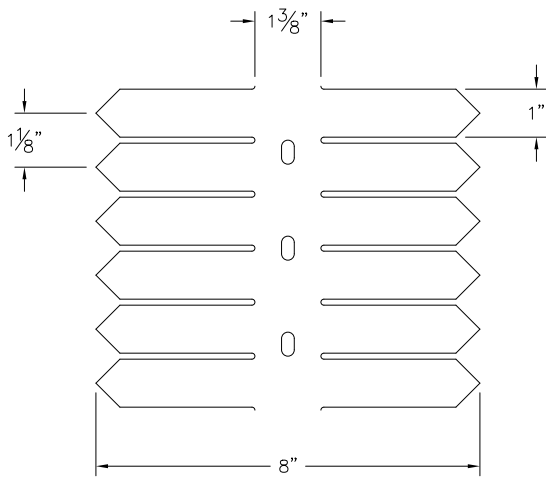

FORM 08 - FLAT

FORM 48

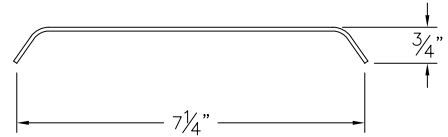

LENGTH	NO. OF FINGERS	FORM 08 - FLAT	FORM 48
18"	32	AL 889-18-P-08-2	AL 889-18-P-48-2
24"	42	AL 889-24-P-08-2	AL 889-24-P-48-2
30"	52	AL 889-30-P-08-2	AL 889-30-P-48-2
36"	64	AL 889-36-P-08-2	AL 889-36-P-48-2
48"	84	AL 889-48-P-08-2	AL 889-48-P-48-2

- MATERIAL: 0.080" 6061-T6 ALUMINUM
- HOLE STYLE: 0.265" X 0.500" ON 2" C.L. SPACING

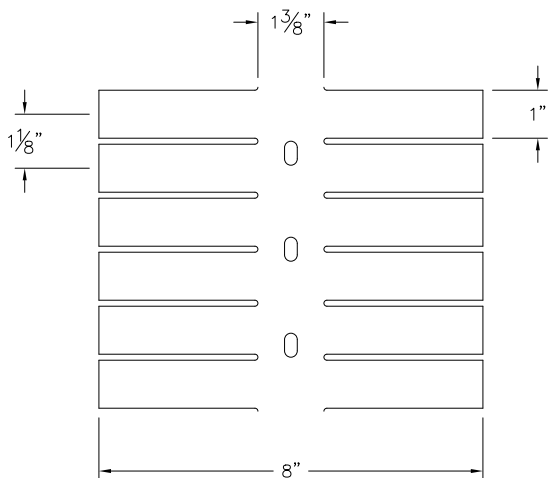

FORM 08 - FLAT

FORM 48

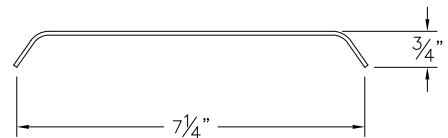

LENGTH	NO. OF FINGERS	FORM 08 - FLAT	FORM 48
18"	32	AL 889-18-F-08-2	AL 889-18-F-48-2
24"	42	AL 889-24-F-08-2	AL 889-24-F-48-2
30"	52	AL 889-30-F-08-2	AL 889-30-F-48-2
36"	64	AL 889-36-F-08-2	AL 889-36-F-48-2
48"	84	AL 889-48-F-08-2	AL 889-48-F-48-2

1 3/8" FINGER SPACING

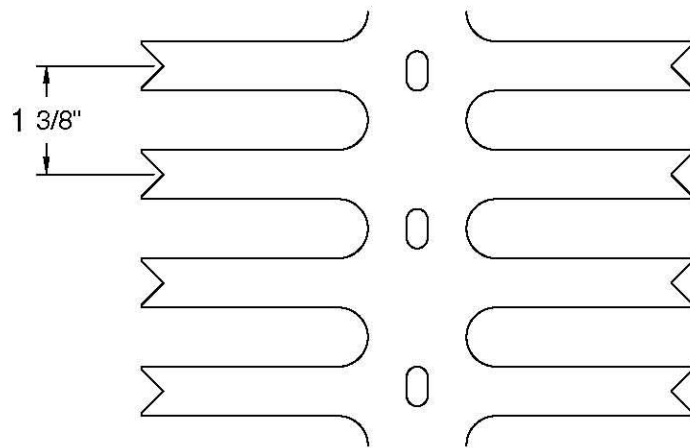

- MATERIAL: 0.080" 6061-T6 ALUMINUM
- HOLE STYLE: 0.265" X 0.500" ON 2" C.L. SPACING
- FINGER HAS 90° NOTCH

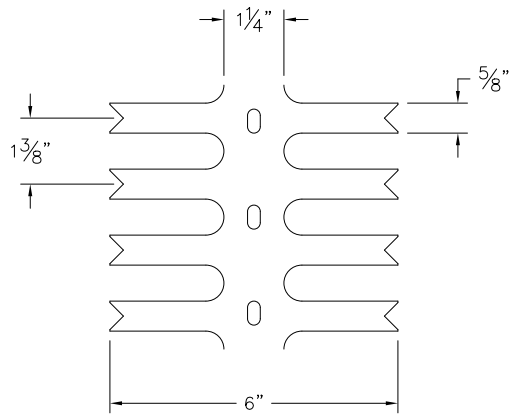

FORM 06 - FLAT

FORM 26

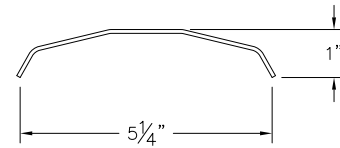

FORM 36

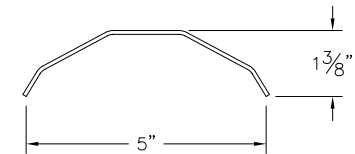

FORM 46

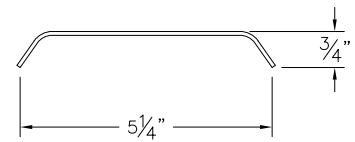

LENGTH	NO. OF FINGERS	FORM 06 - FLAT	FORM 26	FORM 36	FORM 46
18"	26	AL 8511-18-N-06-2	AL 8511-18-N-26-2	AL 8511-18-N-36-2	AL 8511-18-N-46-2
24"	36	AL 8511-24-N-06-2	AL 8511-24-N-26-2	AL 8511-24-N-36-2	AL 8511-24-N-46-2
30"	44	AL 8511-30-N-06-2	AL 8511-30-N-26-2	AL 8511-30-N-36-2	AL 8511-30-N-46-2
36"	52	AL 8511-36-N-06-2	AL 8511-36-N-26-2	AL 8511-36-N-36-2	AL 8511-36-N-46-2
48"	70	AL 8511-48-N-06-2	AL 8511-48-N-26-2	AL 8511-48-N-36-2	AL 8511-48-N-46-2

- MATERIAL: 0.080" 6061-T6 ALUMINUM
- HOLE STYLE: 0.265" X 0.500" ON 2" C.L. SPACING
- FINGER HAS 90° NOTCH

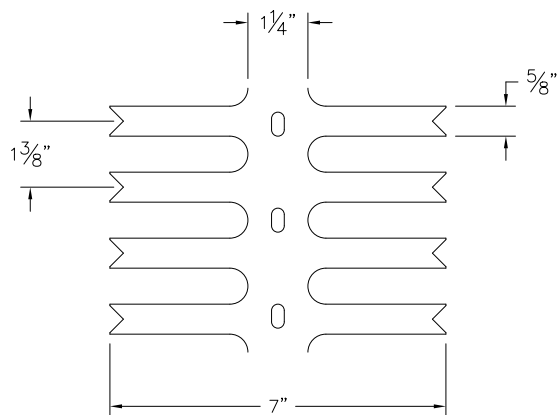

FORM 07 - FLAT

FORM 27

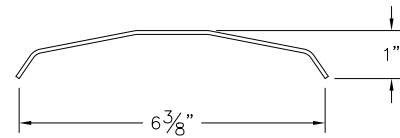

FORM 37

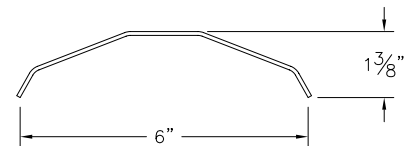

FORM 47

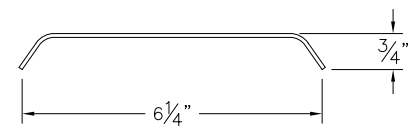

LENGTH	NO. OF FINGERS	FORM 07 - FLAT	FORM 27	FORM 37	FORM 47
18"	26	AL 8511-18-N-07-2	AL 8511-18-N-27-2	AL 8511-18-N-37-2	AL 8511-18-N-47-2
24"	36	AL 8511-24-N-07-2	AL 8511-24-N-27-2	AL 8511-24-N-37-2	AL 8511-24-N-47-2
30"	44	AL 8511-30-N-07-2	AL 8511-30-N-27-2	AL 8511-30-N-37-2	AL 8511-30-N-47-2
36"	52	AL 8511-36-N-07-2	AL 8511-36-N-27-2	AL 8511-36-N-37-2	AL 8511-36-N-47-2
48"	70	AL 8511-48-N-07-2	AL 8511-48-N-27-2	AL 8511-48-N-37-2	AL 8511-48-N-47-2

- MATERIAL: 0.080" 6061-T6 ALUMINUM
- HOLE STYLE: 0.265" X 0.500" ON 2" C.L. SPACING
- FINGER HAS 30° NOTCH

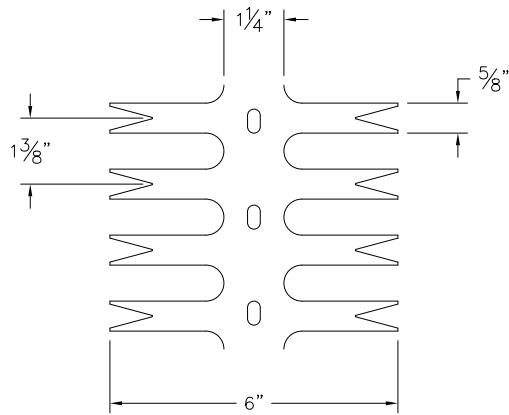

FORM 06 - FLAT

FORM 26

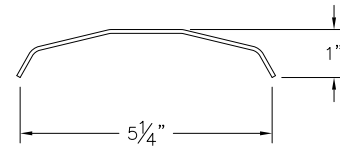

FORM 36

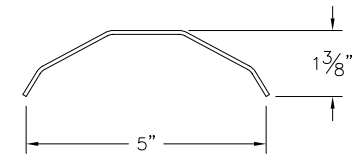

FORM 46

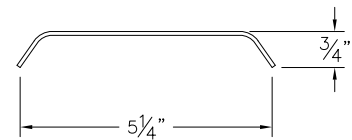

LENGTH	NO. OF FINGERS	FORM 06 - FLAT	FORM 26	FORM 36	FORM 46
18"	26	AL 8511-18-T-06-2	AL 8511-18-T-26-2	AL 8511-18-T-36-2	AL 8511-18-T-46-2
24"	36	AL 8511-24-T-06-2	AL 8511-24-T-26-2	AL 8511-24-T-36-2	AL 8511-24-T-46-2
30"	44	AL 8511-30-T-06-2	AL 8511-30-T-26-2	AL 8511-30-T-36-2	AL 8511-30-T-46-2
36"	52	AL 8511-36-T-06-2	AL 8511-36-T-26-2	AL 8511-36-T-36-2	AL 8511-36-T-46-2
48"	70	AL 8511-48-T-06-2	AL 8511-48-T-26-2	AL 8511-48-T-36-2	AL 8511-48-T-46-2

- MATERIAL: 0.080" 6061-T6 ALUMINUM
- HOLE STYLE: 0.265" X 0.500" ON 2" C.L. SPACING
- FINGER HAS 30° NOTCH

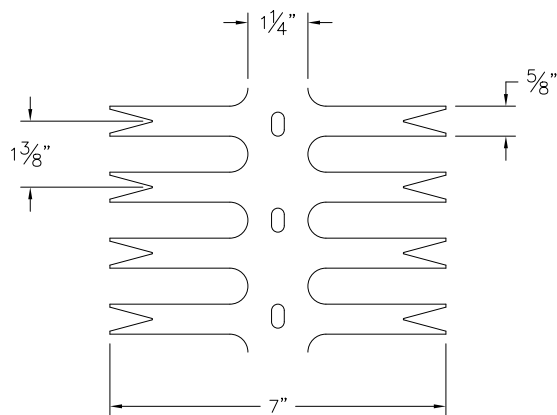

FORM 07 - FLAT

FORM 27

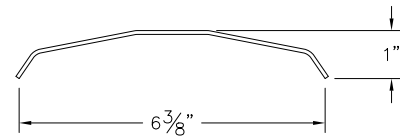

FORM 37

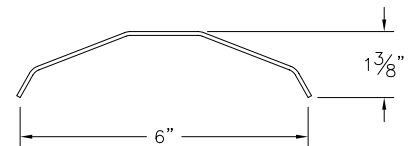

FORM 47

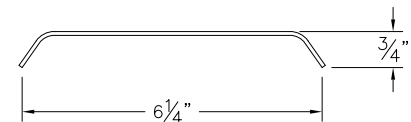

LENGTH	NO. OF FINGERS	FORM 07 - FLAT	FORM 27	FORM 37	FORM 47
18"	26	AL 8511-18-T-07-2	AL 8511-18-T-27-2	AL 8511-18-T-37-2	AL 8511-18-T-47-2
24"	36	AL 8511-24-T-07-2	AL 8511-24-T-27-2	AL 8511-24-T-37-2	AL 8511-24-T-47-2
30"	44	AL 8511-30-T-07-2	AL 8511-30-T-27-2	AL 8511-30-T-37-2	AL 8511-30-T-47-2
36"	52	AL 8511-36-T-07-2	AL 8511-36-T-27-2	AL 8511-36-T-37-2	AL 8511-36-T-47-2
48"	70	AL 8511-48-T-07-2	AL 8511-48-T-27-2	AL 8511-48-T-37-2	AL 8511-48-T-47-2

- MATERIAL: 0.080" 6061-T6 ALUMINUM
- HOLE STYLE: 0.265" X 0.500" ON 2" C.L. SPACING
- FINGER HAS 30° ANGLE WITH SHARP TIPS

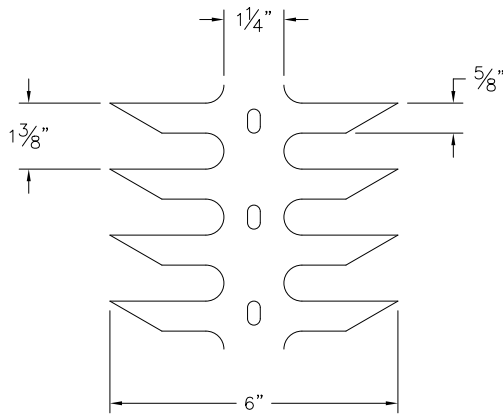

FORM 06 - FLAT

FORM 26

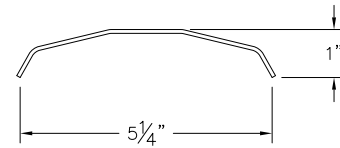

FORM 36

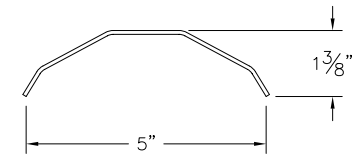

FORM 46

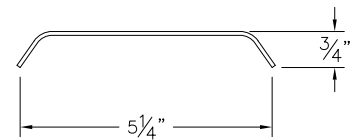

LENGTH	NO. OF FINGERS	FORM 06 - FLAT	FORM 26	FORM 36	FORM 46
18"	26	AL 8511-18-A-06-2	AL 8511-18-A-26-2	AL 8511-18-A-36-2	AL 8511-18-A-46-2
24"	36	AL 8511-24-A-06-2	AL 8511-24-A-26-2	AL 8511-24-A-36-2	AL 8511-24-A-46-2
30"	44	AL 8511-30-A-06-2	AL 8511-30-A-26-2	AL 8511-30-A-36-2	AL 8511-30-A-46-2
36"	52	AL 8511-36-A-06-2	AL 8511-36-A-26-2	AL 8511-36-A-36-2	AL 8511-36-A-46-2
48"	70	AL 8511-48-A-06-2	AL 8511-48-A-26-2	AL 8511-48-A-36-2	AL 8511-48-A-46-2

- MATERIAL: 0.080" 6061-T6 ALUMINUM
- HOLE STYLE: 0.265" X 0.500" ON 2" C.L. SPACING
- FINGER HAS 30° ANGLE WITH SHARP TIPS

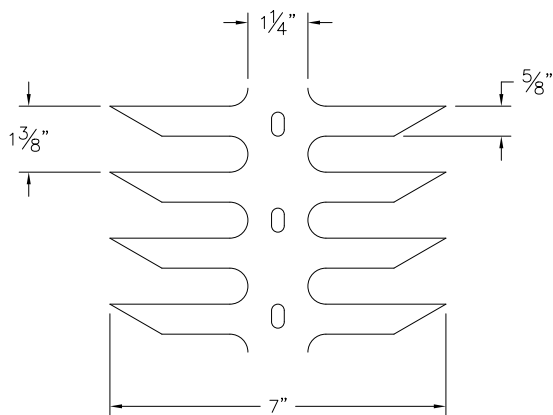

FORM 07 - FLAT

FORM 27

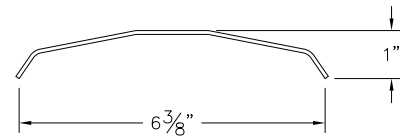

FORM 37

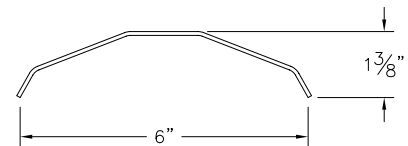

FORM 47

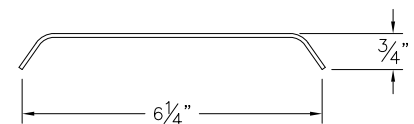

LENGTH	NO. OF FINGERS	FORM 07 - FLAT	FORM 27	FORM 37	FORM 47
18"	26	AL 8511-18-A-07-2	AL 8511-18-A-27-2	AL 8511-18-A-37-2	AL 8511-18-A-47-2
24"	36	AL 8511-24-A-07-2	AL 8511-24-A-27-2	AL 8511-24-A-37-2	AL 8511-24-A-47-2
30"	44	AL 8511-30-A-07-2	AL 8511-30-A-27-2	AL 8511-30-A-37-2	AL 8511-30-A-47-2
36"	52	AL 8511-36-A-07-2	AL 8511-36-A-27-2	AL 8511-36-A-37-2	AL 8511-36-A-47-2
48"	70	AL 8511-48-A-07-2	AL 8511-48-A-27-2	AL 8511-48-A-37-2	AL 8511-48-A-47-2

TAPERED FINGERS

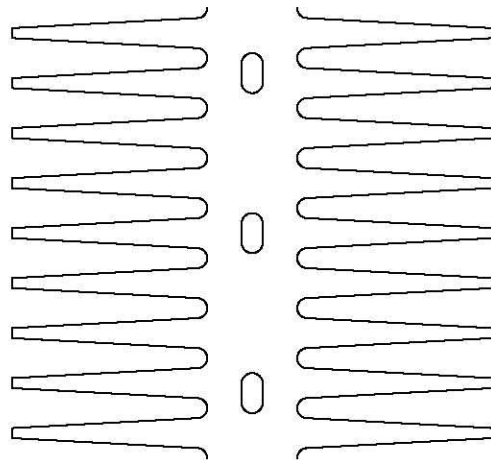

- MATERIAL: 0.080" 6061-T6 ALUMINUM
- HOLE STYLE: 0.265" X 0.500" ON 2" C.L. SPACING

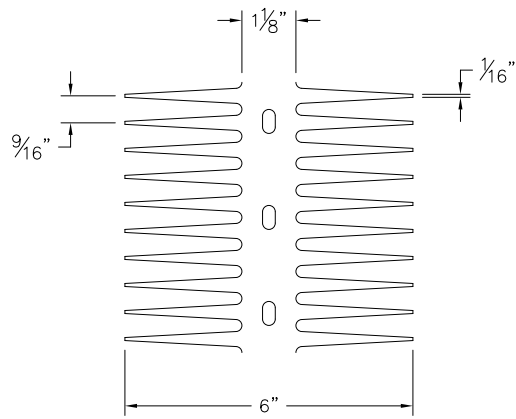

FORM 06 - FLAT

FORM 16

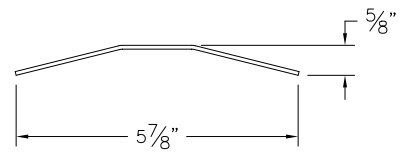

FORM 26

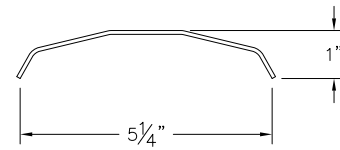

FORM 46

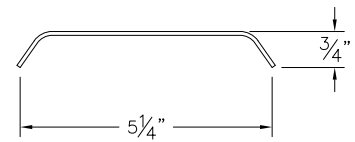

LENGTH	NO. OF FINGERS	FORM 06 - FLAT	FORM 16	FORM 26	FORM 46
18"	72	AL 8.54.5T-18-F-06-2	AL 8.54.5T-18-F-16-2	AL 8.54.5T-18-F-26-2	AL 8.54.5T-18-F-46-2
24"	64	AL 8.54.5T-24-F-06-2	AL 8.54.5T-24-F-16-2	AL 8.54.5T-24-F-26-2	AL 8.54.5T-24-F-46-2
30"	86	AL 8.54.5T-30-F-06-2	AL 8.54.5T-30-F-16-2	AL 8.54.5T-30-F-26-2	AL 8.54.5T-30-F-46-2
36"	108	AL 8.54.5T-36-F-06-2	AL 8.54.5T-36-F-16-2	AL 8.54.5T-36-F-26-2	AL 8.54.5T-36-F-46-2
48"	172	AL 8.54.5T-48-F-06-2	AL 8.54.5T-48-F-16-2	AL 8.54.5T-48-F-26-2	AL 8.54.5T-48-F-46-2

- MATERIAL: 0.080" 6061-T6 ALUMINUM
- HOLE STYLE: 0.265" X 0.500" ON 2" C.L. SPACING

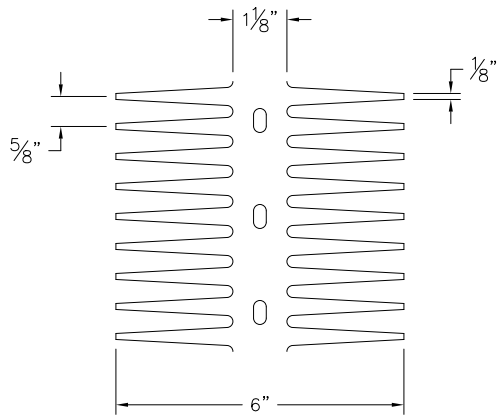

FORM 06 - FLAT

FORM 16

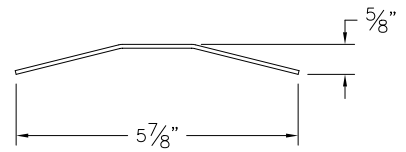

FORM 26

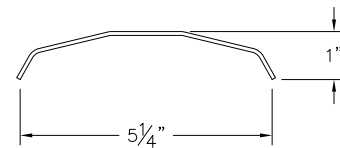

FORM 46

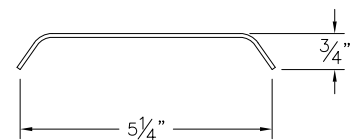

LENGTH	NO. OF FINGERS	FORM 06 - FLAT	FORM 16	FORM 26	FORM 46
18"	58	AL 815T-18-F-06-2	AL 815T-18-F-16-2	AL 815T-18-F-26-2	AL 815T-18-F-46-2
24"	78	AL 815T-24-F-06-2	AL 815T-24-F-16-2	AL 815T-24-F-26-2	AL 815T-24-F-46-2
30"	96	AL 815T-30-F-06-2	AL 815T-30-F-16-2	AL 815T-30-F-26-2	AL 815T-30-F-46-2
36"	116	AL 815T-36-F-06-2	AL 815T-36-F-16-2	AL 815T-36-F-26-2	AL 815T-36-F-46-2
48"	154	AL 815T-48-F-06-2	AL 815T-48-F-16-2	AL 815T-48-F-26-2	AL 815T-48-F-46-2

- MATERIAL: 0.080" 6061-T6 ALUMINUM
- HOLE STYLE: 0.265" X 0.500" ON 2" C.L. SPACING

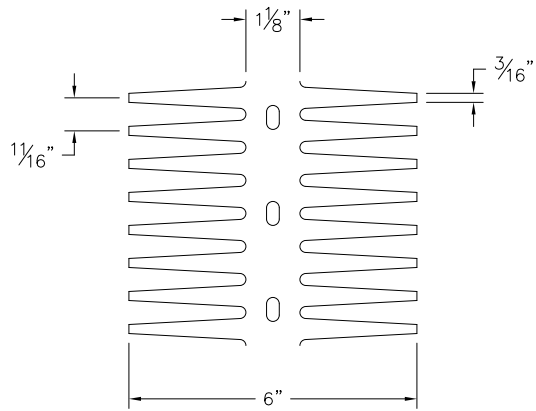

FORM 06 - FLAT

FORM 16

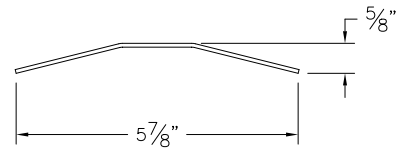

FORM 26

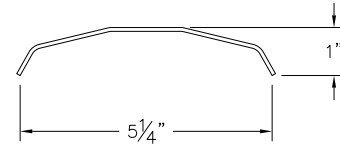

FORM 46

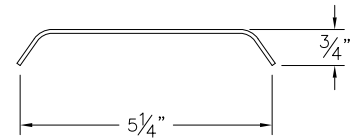

LENGTH	NO. OF FINGERS	FORM 06 - FLAT	FORM 16	FORM 26	FORM 46
18"	52	AL 81.55.5T-18-F-06-2	AL 81.55.5T-18-F-16-2	AL 81.55.5T-18-F-26-2	AL 81.55.5T-18-F-46-2
24"	70	AL 81.55.5T-24-F-06-2	AL 81.55.5T-24-F-16-2	AL 81.55.5T-24-F-26-2	AL 81.55.5T-24-F-46-2
30"	88	AL 81.55.5T-30-F-06-2	AL 81.55.5T-30-F-16-2	AL 81.55.5T-30-F-26-2	AL 81.55.5T-30-F-46-2
36"	106	AL 81.55.5T-36-F-06-2	AL 81.55.5T-36-F-16-2	AL 81.55.5T-36-F-26-2	AL 81.55.5T-36-F-46-2
48"	140	AL 81.55.5T-48-F-06-2	AL 81.55.5T-48-F-16-2	AL 81.55.5T-48-F-26-2	AL 81.55.5T-48-F-46-2

- MATERIAL: 0.080" 6061-T6 ALUMINUM
- HOLE STYLE: 0.265" X 0.500" ON 2" C.L. SPACING

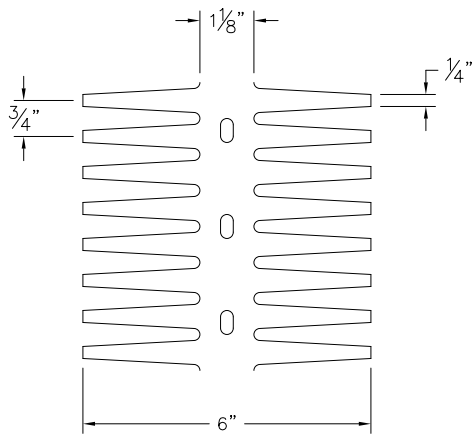

FORM 06 - FLAT

FORM 16

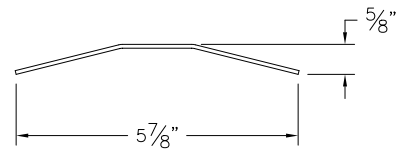

FORM 26

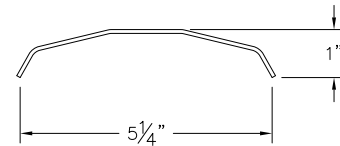

FORM 46

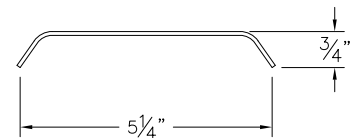

LENGTH	NO. OF FINGERS	FORM 06 - FLAT	FORM 16	FORM 26	FORM 46
18"	48	AL 826T-18-F-06-2	AL 826T-18-F-16-2	AL 826T-18-F-26-2	AL 826T-18-F-46-2
24"	64	AL 826T-24-F-06-2	AL 826T-24-F-16-2	AL 826T-24-F-26-2	AL 826T-24-F-46-2
30"	80	AL 826T-30-F-06-2	AL 826T-30-F-16-2	AL 826T-30-F-26-2	AL 826T-30-F-46-2
36"	96	AL 826T-36-F-06-2	AL 826T-36-F-16-2	AL 826T-36-F-26-2	AL 826T-36-F-46-2
48"	128	AL 826T-48-F-06-2	AL 826T-48-F-16-2	AL 826T-48-F-26-2	AL 826T-48-F-46-2

CLIPS

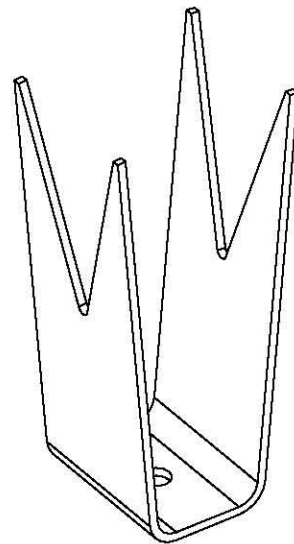
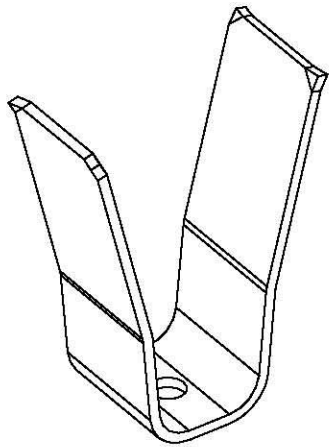

bent corners

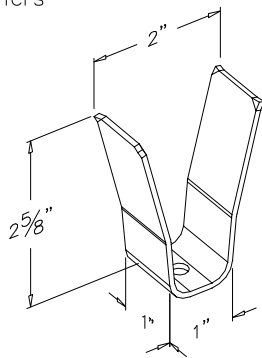

MODEL NO.	HOLE DIA.	MATERIAL
ACL-1000-265-08	0.265	0.080 6061-T6
ACL-1000-328-08	0.328	0.080 6061-T6

.125" notch

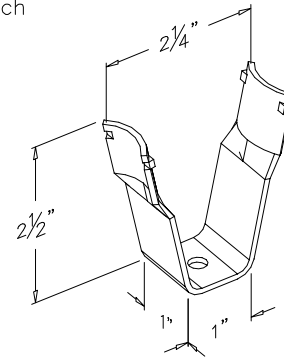

MODEL NO.	HOLE DIA.	MATERIAL
ACL-1011-265-08	0.265	0.080 6061-T6
ACL-1011-328-08	0.328	0.080 6061-T6

.125" notch

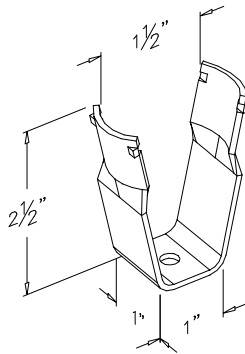

MODEL NO.	HOLE DIA.	MATERIAL
ACL-1012-265-08	0.265	0.080 6061-T6
ACL-1012-328-08	0.328	0.080 6061-T6

.063" tips
35° notch

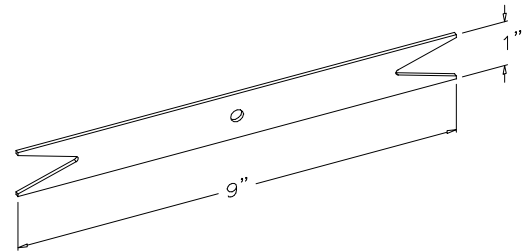

MODEL NO.	HOLE DIA.	MATERIAL
ACL-1030-265-08	0.265	0.080 6061-T6
ACL-1030-328-08	0.328	0.080 6061-T6

.063" tips
35° notch

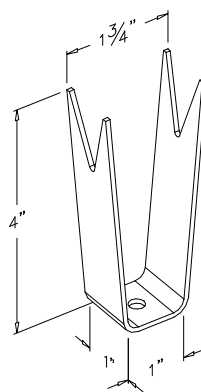

MODEL NO.	HOLE DIA.	MATERIAL
ACL-1031-265-08	0.265	0.080 6061-T6
ACL-1031-328-08	0.328	0.080 6061-T6

.063" tips
35° notch

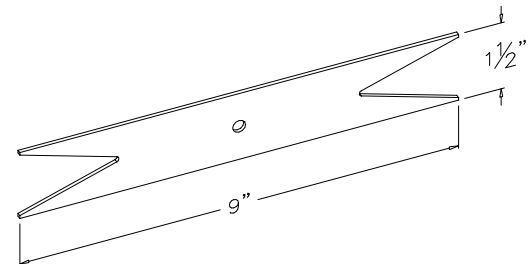

MODEL NO.	HOLE DIA.	MATERIAL
ACL-1040-265-08	0.265	0.080 6061-T6
ACL-1040-328-08	0.328	0.080 6061-T6

.063" tips
35° notch

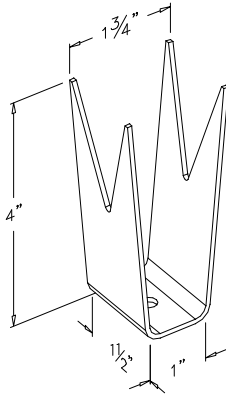

MODEL NO.	HOLE DIA.	MATERIAL
ACL-1041-265-08	0.265	0.080 6061-T6
ACL-1041-328-08	0.328	0.080 6061-T6

.063" tips
35° notch

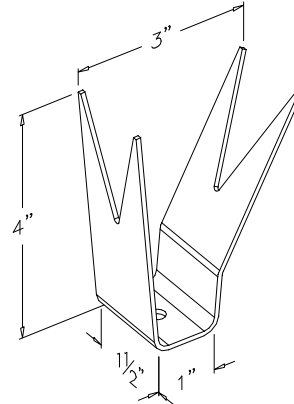

MODEL NO.	HOLE DIA.	MATERIAL
ACL-1044-265-08	0.265	0.080 6061-T6
ACL-1044-328-08	0.328	0.080 6061-T6

.188" tips
35° notch

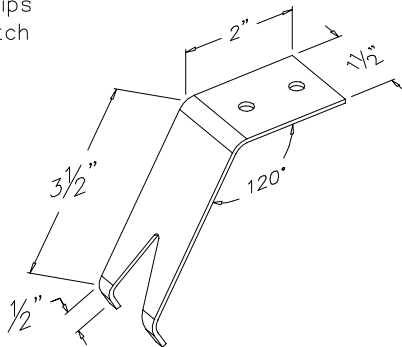

MODEL NO.	HOLE DIA.	MATERIAL
ACL-1021-265-08	0.265	0.080 6061-T6
ACL-1021-328-08	0.328	0.080 6061-T6

.188" tips
35° notch

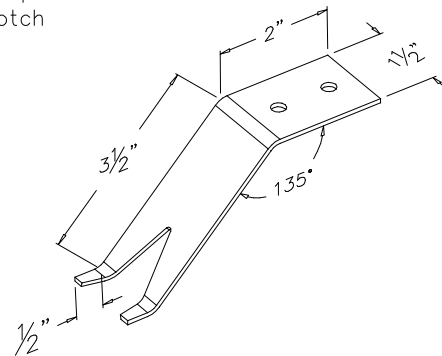

MODEL NO.	HOLE DIA.	MATERIAL
ACL-1022-265-08	0.265	0.080 6061-T6
ACL-1022-328-08	0.328	0.080 6061-T6

.188" tips
35° notch

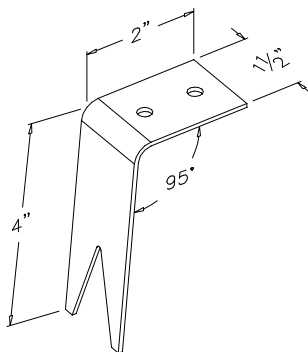

MODEL NO.	HOLE DIA.	MATERIAL
ACL-1023-265-08	0.265	0.080 6061-T6
ACL-1023-328-08	0.328	0.080 6061-T6

.188" tips
35° notch

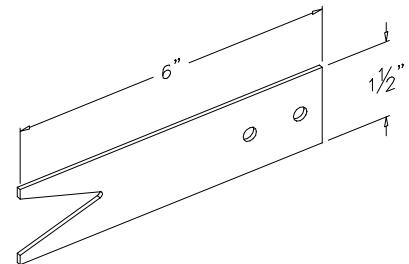

MODEL NO.	HOLE DIA.	MATERIAL
ACL-1024-265-08	0.265	0.080 6061-T6
ACL-1024-328-08	0.328	0.080 6061-T6

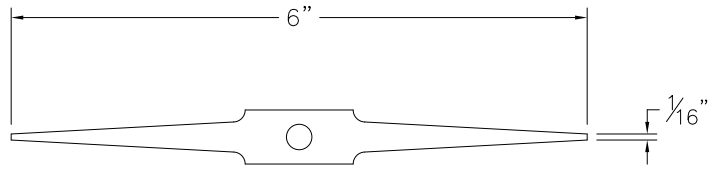

MODEL NO.	HOLE DIA.	MATERIAL
ACL-1060-265-08	0.265	0.080 6061-T6
ACL-1060-328-08	0.328	0.080 6061-T6

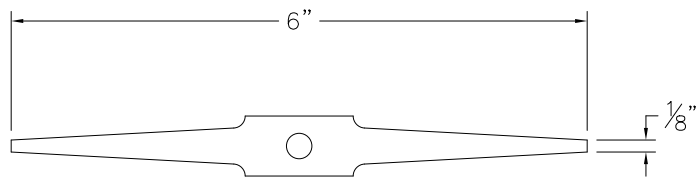

MODEL NO.	HOLE DIA.	MATERIAL
ACL-1070-265-08	0.265	0.080 6061-T6
ACL-1070-328-08	0.328	0.080 6061-T6

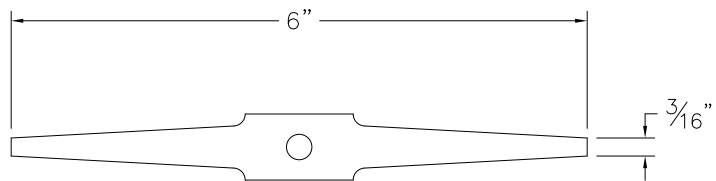

MODEL NO.	HOLE DIA.	MATERIAL
ACL-1080-265-08	0.265	0.080 6061-T6
ACL-1080-328-08	0.328	0.080 6061-T6

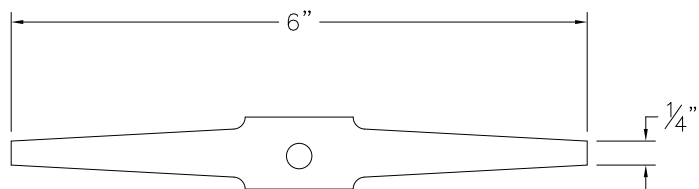

MODEL NO.	HOLE DIA.	MATERIAL
ACL-1090-265-08	0.265	0.080 6061-T6
ACL-1090-328-08	0.328	0.080 6061-T6

ALUMINUM FASTENERS

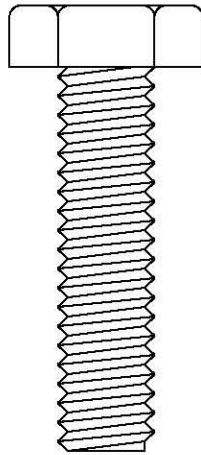

HEX HEAD BOLTS

- MATERIAL: 6061-T6 ALUMINUM
- THREAD: 1/4-20
- 7/16" ACROSS FLAT

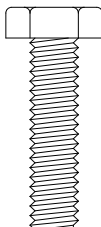
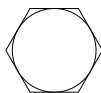

THREAD LENGTH	MODEL NO.
0.500"	AL 1/4-20 X 0.500 HHB
1.000"	AL 1/4-20 X 1.000 HHB
1.250"	AL 1/4-20 X 1.250 HHB
2.000"	AL 1/4-20 X 2.000 HHB

HEX NUTS

- MATERIAL: 6061-T6 ALUMINUM
- THREAD: 1/4-20
- 7/16" ACROSS FLAT

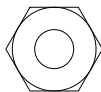

MODEL NO.
AL 1/4-20 HN

FLATWASHERS

- MATERIAL: 6061-T6 ALUMINUM
- 0.625" OUTSIDE DIA., 0.080" THICK
- HOLE FOR 1/4-20 BOLT

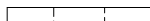
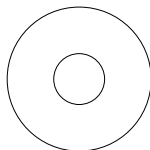

MODEL NO.
AL 1/4 FW